



unity™

DATA ACQUISITION
MANAGER

User's Guide

Proven Solutions for the World of Elections



Wm

Wm

Wm





Proven Solutions for the World of Elections

Data Acquisition Manager

Release 2.0

June, 2001

Election Systems and Software, Inc.
Corporate Headquarters
11208 John Galt Blvd.
Omaha, Nebraska 68137
United States of America
Phone: (402) 593-0101
Toll Free Inside of U.S.: (800) 247-8683
Fax: (402) 593-8107
<http://www.essvote.com>

Copyright © 2001 All Rights Reserved



1992-1993

1992-1993

1992-1993

1992-1993



Vision Statement

Recognized global leader in providing innovative solutions and services to the election industry. These quality solutions and services are developed and delivered by people dedicated to the highest standards of ethics, integrity and the process of continuous improvement.

The result will allow our present and future customers to have a positive and lasting impact on the growth of democracy worldwide.

Who We Are

The World Leader in Automating the Election Process

ES&S is a company of dedicated people building integrated systems and developing solutions for the election official's total management needs

- Election and voter registration management software
- Ballot counting and tabulation hardware
- Election information management software

© 2001 by Election Systems & Software, 11208 John Galt Blvd., Omaha, NE 68137-2364.
All rights reserved. Printed in the USA

All information contained in this manual is proprietary to Election Systems & Software. No part of this document may be photocopied or reproduced in any manner without the prior consent of Election Systems & Software.

The Data Acquisition Manager is a trademark of Election Systems & Software. Windows and Windows 95 are trademarks of the Microsoft Corporation. All other products mentioned are the sole property of their respective manufacturers.

Disclaimer

Election Systems & Software does not extend any warranties by this document. All product information and material disclosure contained in this document is furnished subject to the terms and conditions of a purchase or lease agreement. The only warranties made by Election Systems & Software are contained in such agreements. Users should ensure that the use of this equipment complies with all legal or other obligations of their governmental jurisdictions.

Data Acquisition Manager is a registered trademark of Election Systems & Software Inc.

Table of Contents

Chapter 1: Introduction	1
Contacting ES&S for Software Support	2
Chapter 2: Configuration Options	3
Chapter 3: Hardware Installation Procedures.....	11
SPR Host Unit.....	11
4-Port Communications Board and Modem Installation	11
LAN Card Installation.....	13
SPR Sending Unit	14
Pack Interface Card Installation	14
Communications Configuration Options	16
SPR with Modem.....	16
SPR with Direct Cable	18
SPR with Lan	19
LAN Card Installation.....	19
Network Attached SPR Unit.....	19
SPR with Tabulators	21
Chapter 4: Software Installation Procedures.....	22
SPR Host Unit.....	22
SPR Sending Unit	22
Chapter 5: Setting up Data Acquisition Manager	23
Setting up Acquisition Manager Security	23
Starting the SPR Host	24
SPR Remote Unit.....	28
Chapter 6: Acquisition Manager Operation	31
SPR Host.....	31
Setting up the Data Acquisition Manager	31
Running the Software	32
Configuring the SPR Remote Unit	42
Machine Setup	42
Running the Software	43
Configuring a Local SPR Unit.....	56
Using Acquisition Managers with Modems.....	67
SPR Host Installation.....	68
SPR Host Setup.....	68
Counter Installation.....	68

SPR Parallel Remote Setup.....	69
SPR Host Setup.....	74
Setting up Acquisition Manager with a Model 2100	75
SPR with Model 2100 Installation.....	75
SPR with Model 2100 Remote Setup	76
SPR Host Setup.....	80
Chapter 7: IDA Board	81
Size and Weight	81
Principles of Operation	81
Interface with SPR	81
Installing the IDA Board.....	82
IDA Operation.....	83
Hardware Installation Procedures	84
SPR Host Unit.....	84
Remote Regional Site Sending Units.....	85
Chapter 8: Files Definition.....	88
Files Needed To Run the Host.....	88
Files Needed To Run the Remote	89
Chapter 9: Error Messages	90
Appendix A: Sample Configurations	97
Sample Configuration for Host.....	97
Sample Configuration for Remote Unit.....	101
Sample Configuration for Host with Four Serial Ports	103
Sample Configuration for Host With Six Serial Ports	104
Appendix B: Cable/Connector Wiring Diagrams.....	105
Loop Back Test Connector	105
SPR Direct Connect Handshake Null-Modem Adapter.....	107
Appendix C: Acquisition Manager Utilities	109
Log Program	109
SPR Host and Remote Log Entry Codes.....	109
Sample Logs.....	110
Host Log.....	110
Remote Log.....	112
Pack Queue Displayer (AQ.EXE).....	114
Pack Read Tester (PACKRDR.EXE)	114

Appendix D: Hardware Programming Manager and Acquisition Manager	115
Using Acquisition Manager with the Hardware Programming Manager	115
Changing the System Control File	115
Creating the SPR Control File	116
Running the SPR Precinct Results Update	118
Glossary	121

1. The first part of the document discusses the importance of maintaining accurate records of all transactions and activities. It emphasizes the need for transparency and accountability in financial reporting.

2. The second part of the document outlines the various methods and techniques used to collect and analyze data. It highlights the importance of using reliable sources and ensuring the accuracy of the information gathered.

3. The third part of the document discusses the challenges and limitations of data collection and analysis. It notes that while technology has advanced significantly, there are still many obstacles to overcome, such as data privacy concerns and the complexity of large datasets.

4. The fourth part of the document provides a summary of the key findings and conclusions. It reiterates the importance of continuous monitoring and evaluation to ensure the effectiveness of the data collection and analysis process.

Chapter 1: Introduction

Use Election Systems and Software's Data Acquisition Manager to accumulate Election Day results from ballot scanning equipment. Load the results into the Election Reporting Manager to produce election results reports. Acquisition Manager transmitting units can be connected from a remote site (via telephone) or connected locally (direct connect). Precinct ballot scanners equipped with modems, such as the Model 100, the Votronic and the iVotronic, can send election results from a remote site. The Acquisition Manager Host computer has the ability to receive multiple calls simultaneously from sending units and scanners equipped with modems. When the Acquisition Manager Host computer receives a call, it automatically sends a list of precincts to the remote. The remote operator uses this list to determine which data packs still need to be sent.

Minimum requirements for the Acquisition Manager Host computer:

- A PC-386 or PC-486 running at speeds of 33MHz or greater with a minimum of 4Mb of RAM memory.
- A 14-inch VGA monitor is preferred, but
- Two communication ports (standard on most PC's) to attach an external dial-up modem with baud rates of 9600

In addition, a four-port (ISA) serial communication interface board can be installed in the Acquisition Manager Host system if additional lines are required. The interconnecting fan-out cable supplied with this board will be directly connected to as many as four external dial-up modems (Hayes™ compatible preferred) with baud rates of up to 9600.

A 17-inch VGA unit is ideal if operated in the 43-line mode.

Minimum requirements for the Acquisition Manager Remote Sending Unit:

- A PC compatible computer with an internal ES&S designed pack interface card
- A Hayes™ compatible internal modem (remote operation only)
- A mechanical pack insertion fixture capable of reading data packs from tabulators

Note: The Data Acquisition Manager is also known as the Smart Pack Reader (SPR). In this manual, the names Data Acquisition Manager and Smart Pack Reader refer to the same data transfer system.

Contacting ES&S for Software Support

This manual should aid in accomplishing most of the tasks in the Data Acquisition Manager. The first step to answering any questions is to consult product documentation.

If a question cannot be answered with these resources, or if a processing problem or system error is encountered, ES&S's software support staff can provide advice and assistance in resolving the situation.

When calling ES&S for software support, please be near the computer. In addition, be prepared to provide the following information to the support representative:

- **The version number** of the product.
- **The type of hardware** used, including network hardware if applicable.
- **The operating system** (e.g., Windows 95).
- **The exact wording of any messages** appearing on screen.
- **A description of what happened**, circumstances under which the problem occurred and any solutions attempted.

Support representatives are available between 8:00 a.m. and 5:00 p.m. CST; however, support hours are extended during election periods.

To contact an ES&S support representative:

Telephone: 800-247-8683 (USA & Canada) or
402-593-0101 (International)

Fax: 402-593-8107

Write: Election Systems & Software
11208 John Galt Blvd.
Omaha, NE 68137 USA

ES&S's support services are subject to ES&S's prices, terms, and conditions in place at the time the service is used.

Chapter 2: Configuration Options

The diagrams on the following pages suggest a number of options for configuring a system.

1944

1945

1946

1947

1948

1949

1950

1951

1952

1953

1954

1955

1956

1957

1958

1959

1960

1961

1962

1963

1964

1965

1966

1967

1968

1969

1970

1971

1972

1973

1974

1975

1976

1977

1978

1979

1980

1981

1982

1983

1984

1985

1986

1987

1988

1989

1990

1991

1992

1993

1994

1995

1996

1997

1998

1999

2000

2001

2002

2003

2004

2005

2006

2007

2008

2009

2010

2011

2012

2013

2014

2015

2016

2017

2018

2019

2020

2021

2022

2023

2024

2025

LOCAL

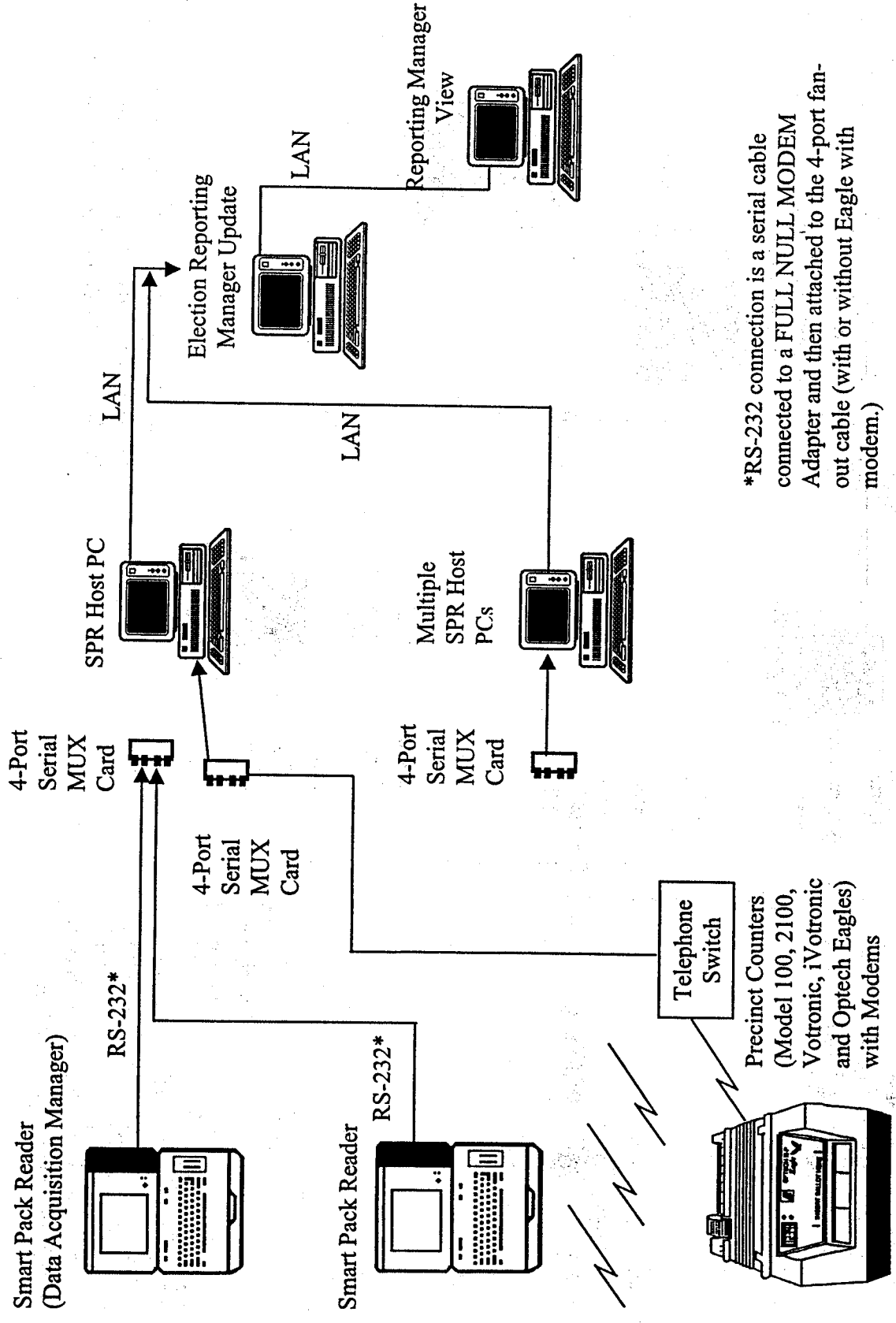

*RS-232 connection is a serial cable connected to a FULL NULL MODEM Adapter and then attached to the 4-port fan-out cable (with or without Eagle with modem.)

Remote

Smart Pack Reader
(Data Acquisition Manager)

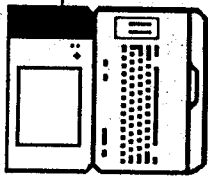

Smart Pack Reader

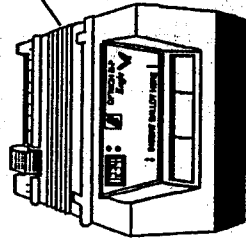
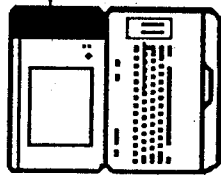

Precinct Counters
(Model 100, 2100,
Votronic, iVotronic
and Optech Eagles)
with Modems

Telephone
Switch

4-Port
Serial
MUX
Card



Multiple
SPR Host
PCs

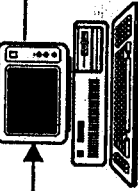

SPR
Host PC

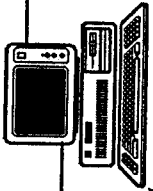

4-Port
Serial
Mux
Card



4-Port
Serial
Mux
Card



Election Reporting
Manager Update

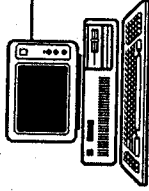

LAN

Reporting
Manager View

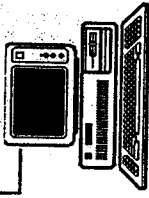

LAN

Note: External modems are connected directly to the 4-port card using the 4-conductor fan-out cable (with or without Eagle with modem).

LAN

Smart Pack Reader
(Data Acquisition Manager)

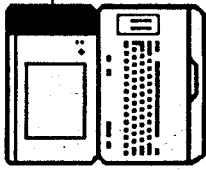

LAN

Election Reporting Manager Update

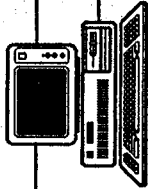

LAN

Reporting Manager View

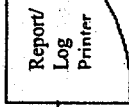
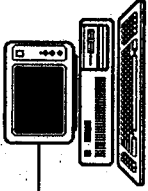

Optional ALL Configurations

Smart Pack Reader

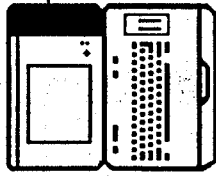

LAN

Model 2100
Model 100
Internal PCMCIA Slot

V-2000 & Eagle MPR IDA

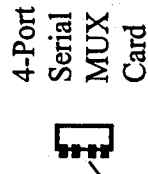

SPR Host

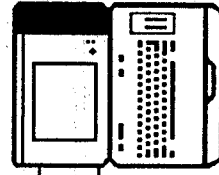

Telephone Switch

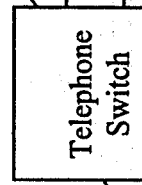

Precinct Counters
(Model 100, 2100, Votronic, iVotronic and Optech Eagles) with Modems

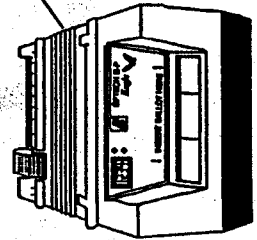

Direct Shared PC

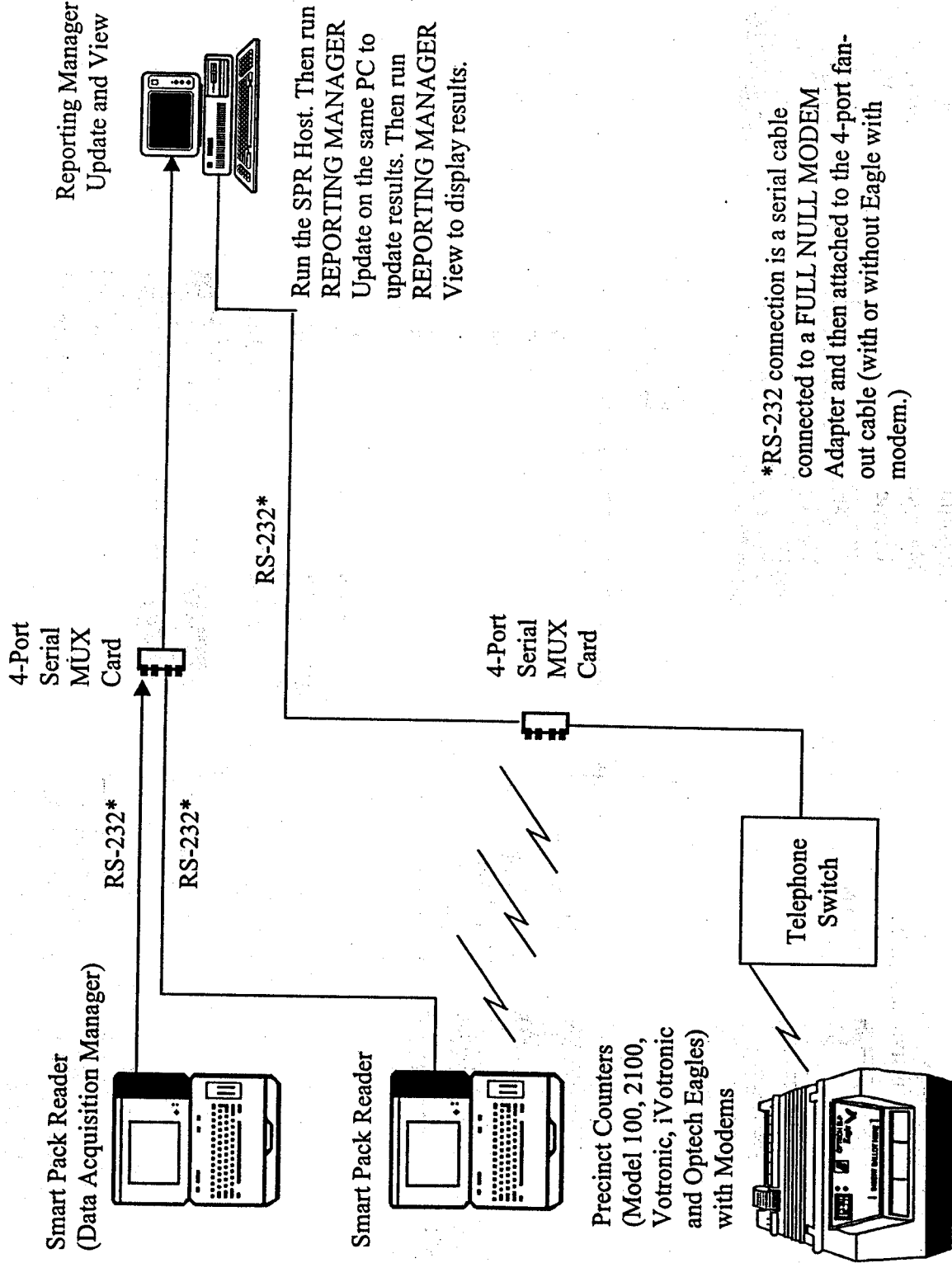

*RS-232 connection is a serial cable connected to a FULL NULL MODEM Adapter and then attached to the 4-port fan-out cable (with or without Eagle with modem.)

Diskette

Smart Pack Reader
(Data Acquisition Manager)

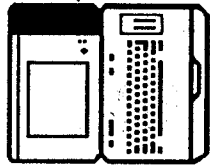

Create
diskette



Reporting
Manager

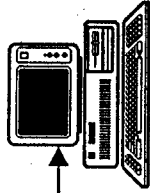

Ballot Scanner

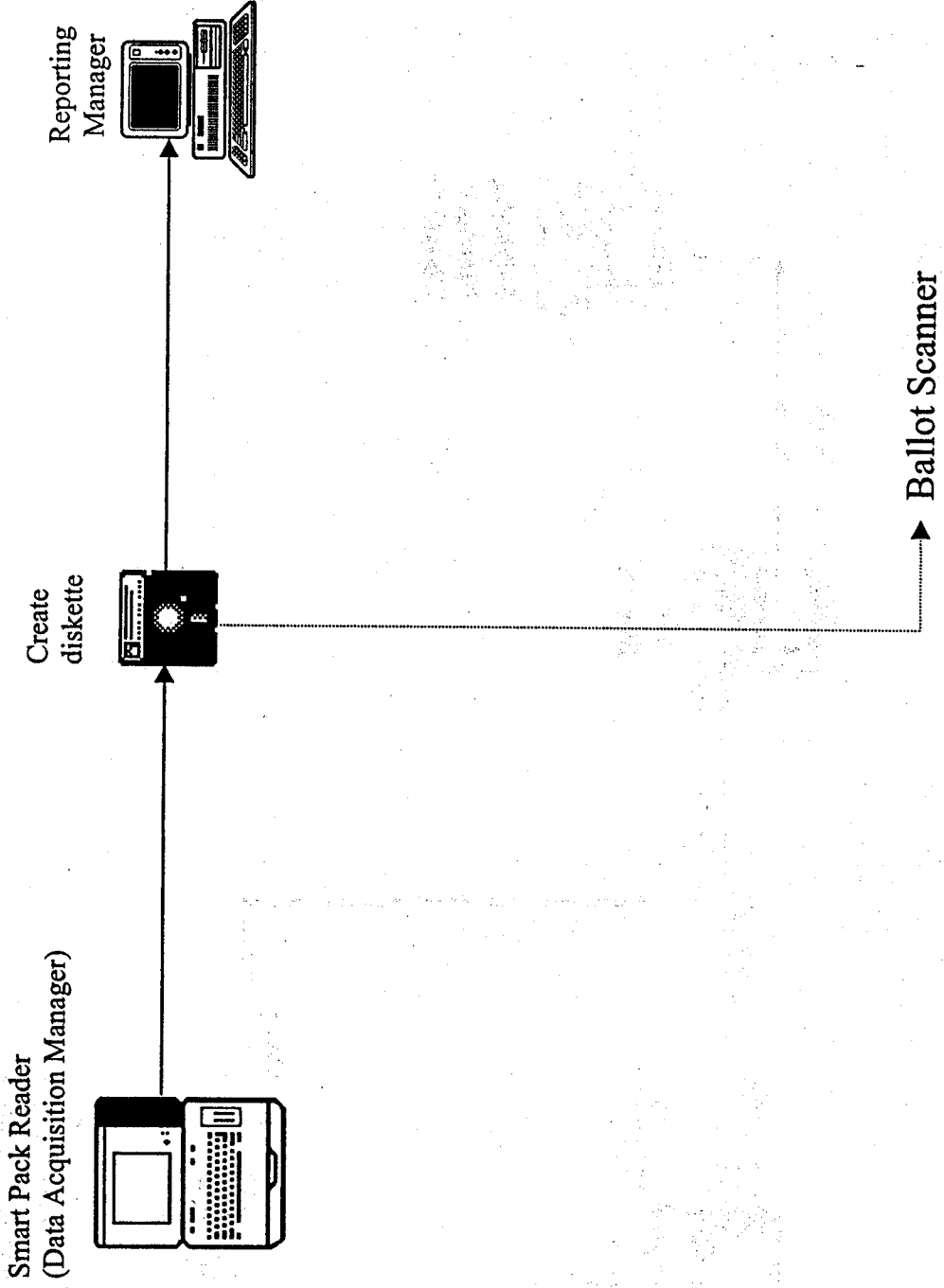

Remote Minimal Configuration

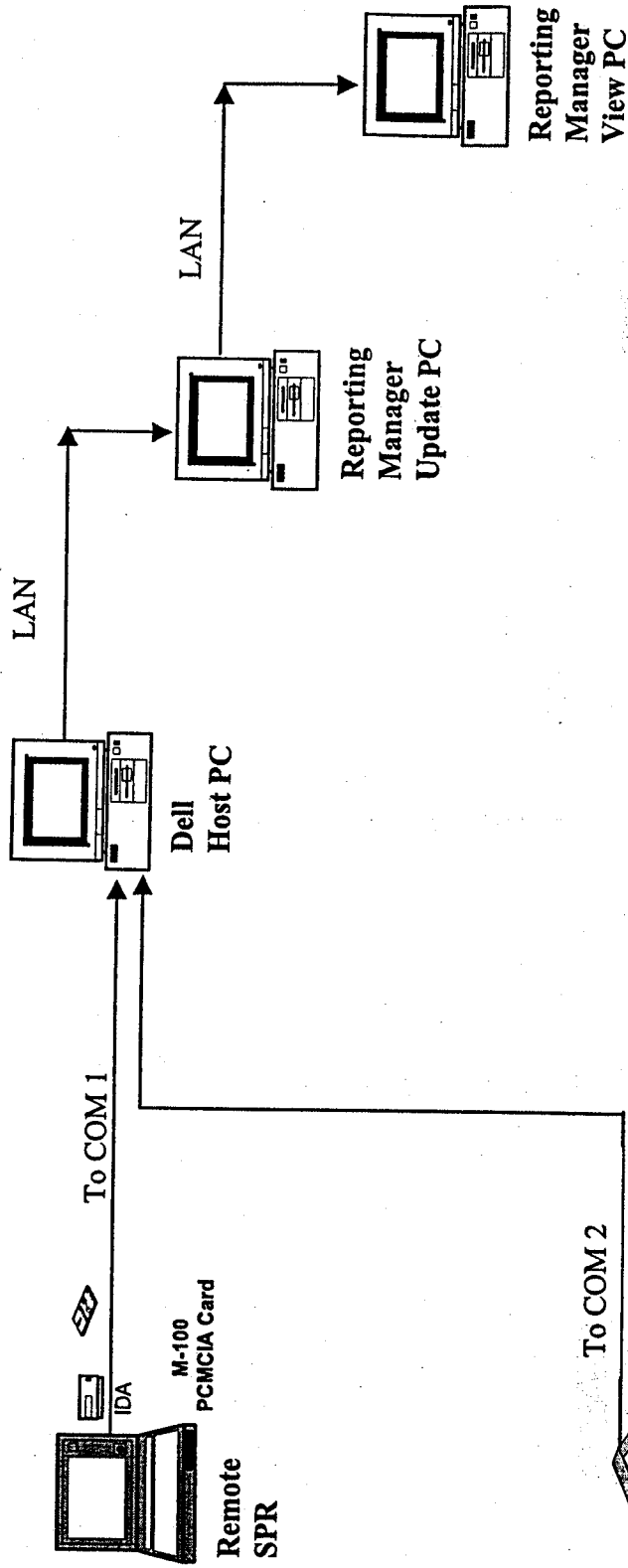

**Precinct Counters
(Model 100, 2100,
Votronic, iVotronic
and Optech Eagles)
with Modems**

Chapter 3: Hardware Installation Procedures

Data Acquisition Manager includes an SPR Host Unit that receives election results and a SPR sending unit.

SPR Host Unit

An SPR Host computer is connected to the remote SPR unit(s) via dial-up telephone lines. The SPR HOST utilizes external modems connected to the SPR remote sending unit's internal modem.

4-Port Communications Board and Modem Installation

1. Install a 4-port communications board in any empty slot in the SPR Host computer unit. See Figure 1 below.

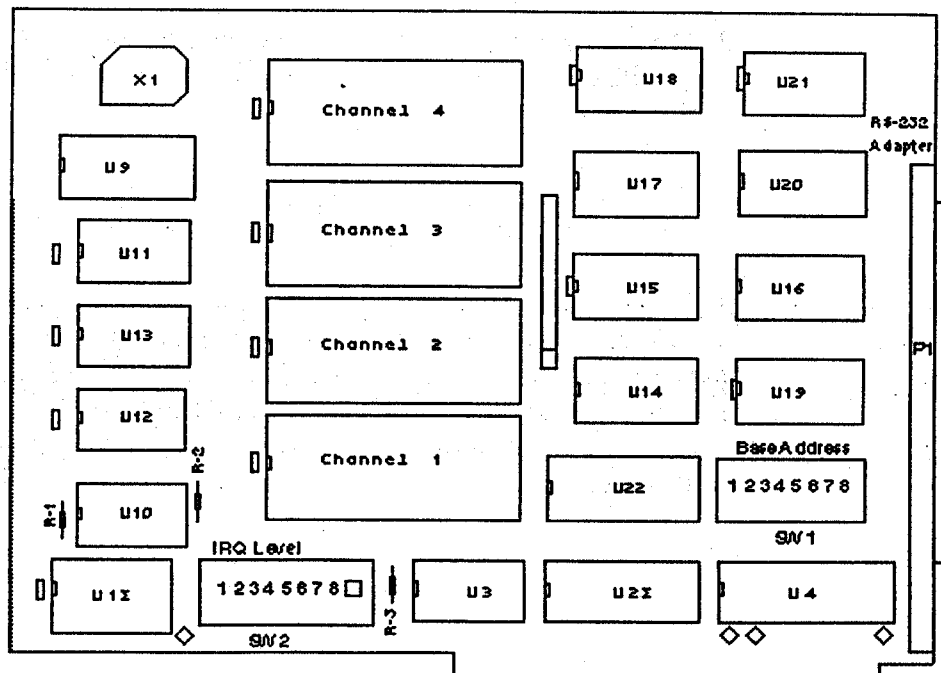

Fig. 1 4-Port Communications Board Diagram

Note: If the IRQ and port base address conflict with other installed options, set the IRQ and address to an unused value.

The default IRQ setting is 5. The default Port Base Address is 280 HEX. The default dip switches are shown in Figure 2 below.

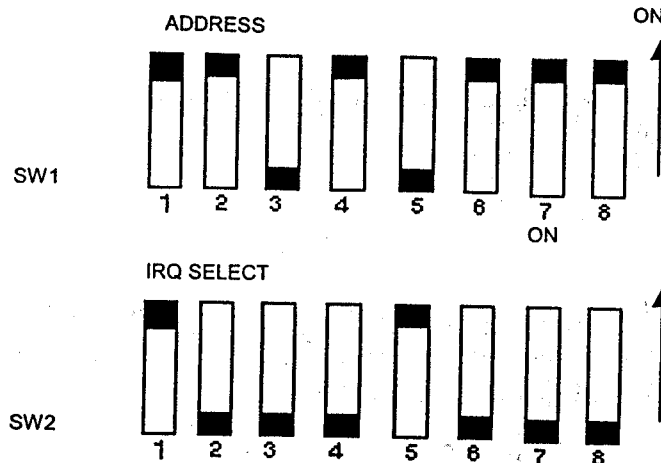

Fig. 2 Base Address and IRQ Default Switch Settings

2. The 4-port cable assembly is supplied with the 4-port communication board. Connect the 50-pin connector on the cable to the rear of the 4-port board.
3. Connect one 25-pin cable connector to each port connector at the rear of each external Hayes compatible modem for each remote SPR unit.

If the SPR sending unit will be connected directly to the SPR Host, use the direct-connect cable that is provided to connect between any one of the four 25-pin connectors and the serial (RS-232) connectors on the SPR sending unit (COM1 or COM2). An ES&S FULL HANDSHAKE NULL MODEM adapter must be used on the SPR Host RS-232 cable if it is to be directly connected to an SPR sending unit.

LAN Card Installation

If the SPR HOST is connected to a LAN, install the LAN card per instructions from the vendor. Be sure to set the IRQ and LAN board address different from that of the 4-port card.

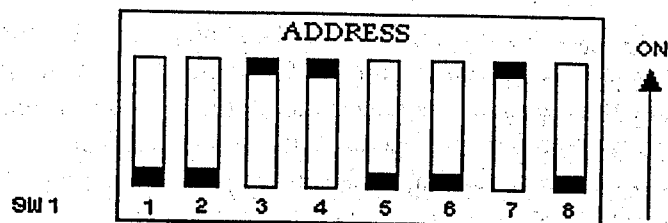

Fig. 3 Pack Interface Board Address

SPR Sending Unit

Pack Interface Card Installation

1. Remove the ribbon cable from the LCD display on the SPR sending unit. Disconnect the lid brace from the CPU chassis. Remove the four screws holding the computer/keyboard unit in the case. Then remove the computer from the case. Remove the eight computer cage screws in order to access the computer slots. Insert the pack interface in the slot closest to the top (nearest the keyboard) of the unit.
2. Set the pack interface board address to 260 Hex as shown in Figure 3.

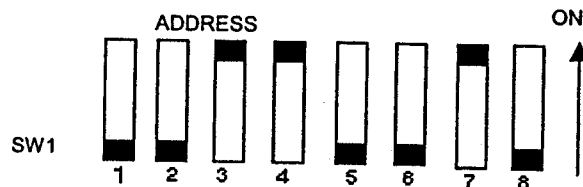

Figure 3. Pack Interface Board Address

3. Attach the short ribbon cable stub into the edge connector of the pack interface card.

Note: The connectors may not be keyed. The red wire of the cable is pin #1.

4. Remove the four screws holding the cover plate on the *external option* hole. Remove the cover plate.

5. Attach the ribbon cable from the pack fixture to the ribbon stub installed in the pack interface card.

If you are using a modem, refer to page 14 for installing the internal modem before reattaching the lid to the SPR unit. If you are not using a modem, continue with the steps below.

6. Using the four screws removed from the access plate, install the pack fixture into the access hole. Carefully pack the cables into the access area.
7. Place the CPU/keyboard unit back into the carrying case and replace the four screws that you removed in 1 above.
8. Reinstall all cover plates, and attach the lid brace and LCD cable.

Communications Configuration Options

SPR with Modem

A remotely connected SPR sending unit is connected to the SPR Host computer via a dial-up telephone line through the SPR sending unit's internal modem. The modem is connected to any conventional dial-up telephone line via the 4-pin modular (RJ-11) jack that is located at the top of the pack interface card. The modem may be set as either COM1 or COM2. Refer to the SPR configuration file to inform SPR of the modem assignment port.

After installing the pack interface card, perform the steps below to install the internal modem before reinstalling the SPR CPU/keyboard unit back into the case.

1. Set the DIP switches on the modem for the appropriate COM port according to Figure 4 below.

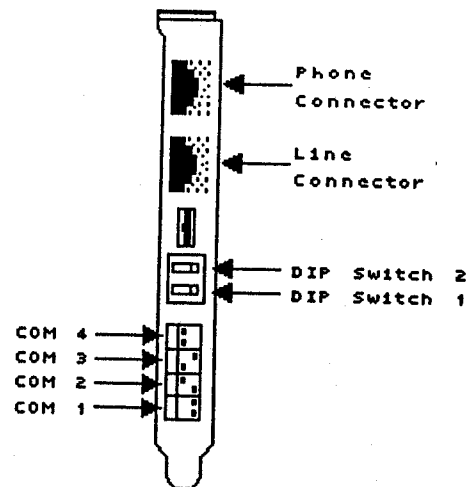

Figure 4. Internal Modem Diagram

2. With the mounting bracket and phone jacks facing toward the rear of the computer, insert the edge connector of the Hayes compatible internal modem into any unused slot and set for COM1 or COM2.

Note: If the modem is to be on COM1, the BIOS CMOS configuration must be set to disable for the SPR's internal COM1 port.

3. Insert a short telephone jack cord into the modem line connector.
4. Insert the telephone cord from the pack interface card into the cord from the modem card.
5. Using the four screws removed from the access plate, install the pack fixture into the access hole. Carefully pack the cables into the access area.
6. Reinstall all cover plates, and place the CPU/keyboard unit back into the carrying case. Attach the lid brace and LCD cable.

SPR with Direct Cable

A directly connected (RS-232) data pack reader unit consists of an SPR sending unit without the internal modem used for the remote sending unit.

Note: The SPR Host must be running before making the connection with the local SPR unit.

1. Use the ES&S supplied FULL HANDSHAKE NULL MODEM adapter cable to connect from the end(s) of the 4-port communications cable assembly on the SPR Host to the COM1 or COM2 port of the SPR local sending unit.
2. Check the SPR's BIOS configuration to see that the COM port being used is enabled.

Note: If the SPR sending unit has an internal modem installed, insert the direct connect cable into the unused *COM* port. (The modem is normally set for *COM1*.)

SPR with Lan

LAN Card Installation

If the SPR Host is connected to a LAN, install the LAN card according to the instructions from the vendor. Be sure to set the IRQ and LAN board address different from that of the RS-232 communications ports.

Network Attached SPR Unit

Version 1.97 allows you to operate on the network without modems and enables reading packs locally multiple times.

1. Open the SPR.cfg file and set the second port on the list of serial devices to a baud rate of 19,200. (The first port is the modem.)
2. In the SPR Remote Setup, select Product.
3. Select Readeronly.

Smart Pack Header Setup		(c)2001 Election Systems & Software	
Quit		REMOTE SETUP	
Get Setup		Configuration File: SPR.CFG	
Save S	Product Setup		
Defaul	Reader Only: YES	READERONLY	
Electi	MAN:	MAN	
Serial			
Displa			
Server			
Host Path		Host Path: C:\SPR	
Phone		Phone Number: 13077398634	
Password		Password: 00005657	
Memory Packs		Pack Type: EAGLEMAN	
Site		Pack Interface: IDA	
Product		Host Name:	
		Host Unit:	
		District: 0001	
		District Name: TEST SITE	
		Reader Only: YES	
		MAN:	

When Readeronly is selected, the program will read from the MPR and put that information into an .spp file. It will allow the same pack to be read multiple times, appending each read to the .spp file.

4. Select YES, and press ESC.

Now when you run SPR, the station number will display at the top of the SPR screen to the left of the version number. If NO is selected, the Remote number will display. The station number is defined by **sprunit=** under SITE in the SPR.cfg file.

5. Press ESC to return to the Setup screen.
6. Select Save setup.
7. Select Quit and press F3 to confirm it.
8. Click the **MPR Boot** icon. This action sends a file to the MPR, enabling communication between the SPR and the MPR.
9. At the C:\SPR prompt, type SPR.
10. Press ENTER at the Copyright screen.

The screen will look like the one shown below.

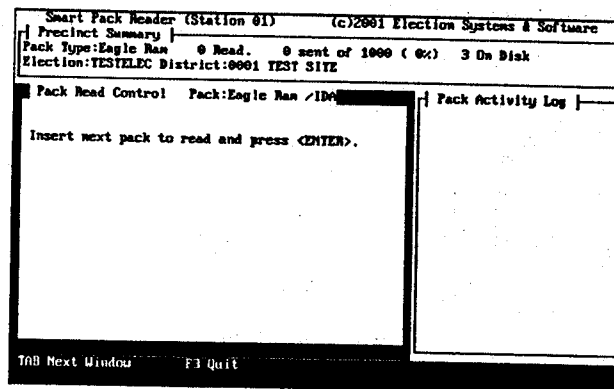

SPR with Tabulators

A tabulator that is equipped with a modem can transmit election results directly to an SPR Host unit over a Land Line dial-in. Use the installation procedure for the SPR Host on page 11.

Chapter 4: Software Installation Procedures

SPR Host Unit

Follow the steps below to install the SPR Host software.

1. Insert the ES&S SPR Host program diskette into the SPR HOST computer diskette drive and type **A:INSTALL**.

SPR Sending Unit

Follow the steps below to install the SPR Remote software.

1. Insert the ES&S **REMOTE** program diskette into the SPR diskette drive and type **A:INSTALL**.

Chapter 5: Setting up Data Acquisition Manager

Setting up Acquisition Manager Security

You can set up passwords for the Data Acquisition Manager Host, Remote and Setup applications.

To set up Acquisition Manager security:

1. Open the Data Acquisition Manager Setup application by clicking **Start** on the Windows desktop. Point to **Programs** then **ES&S Data Acquisition Manager** and then select **Setup** from the Acquisition Manager submenu. The following screen will appear:

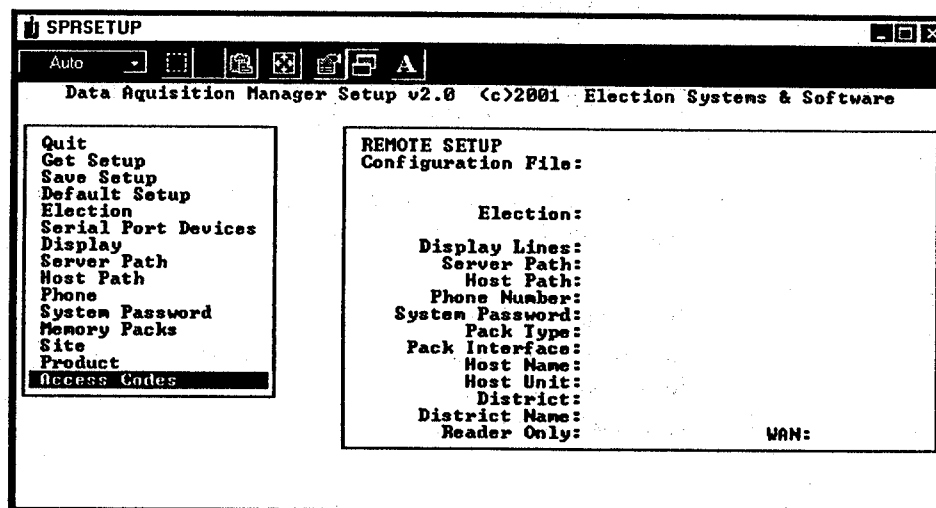

2. Select **Access Codes** from the menu on the left of the screen and press **ENTER**. The following window will appear:

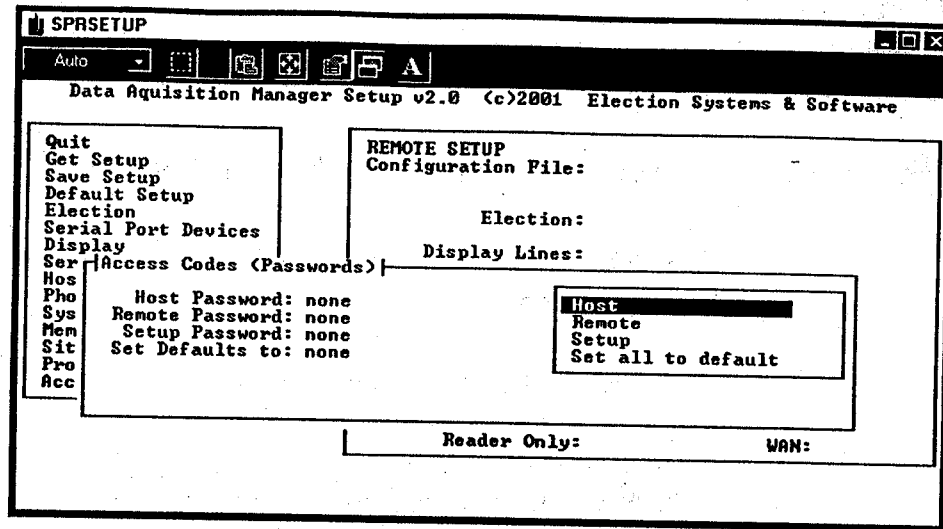

3. Select the application you want to set a password for from the menu on the right and press **ENTER**.
4. Enter the password (up to eight characters) and press **ENTER** to set the password for the selected application.
5. Use the instructions above to set up passwords for each of the applications you want to limit access to.

Note: Set a default password to allow access to all Acquisition Manager applications without entering a password. After passwords have been set, you will be allowed three attempts to enter the correct code whenever you open an Acquisition Manager application.

Starting the SPR Host

The following procedure must be followed when starting the SPR Host System the first time. In addition, this procedure must be followed whenever a zeroed-out restart is needed to re-transmit the same election or to begin transmission of a new election.

1. Run the SPR setup program. At the C:\SPR prompt, type **SPRSETUP** and press **ENTER**.

With this program, changes may be made to the setup by selecting menu options.

2. Select Get Setup from the menu and enter **HOST.CFG** to load the Host configuration file. Then make any necessary changes to the file.
3. After all of the required changes have been made, select Save Setup from the main menu, and save the setup as **HOST.CFG**.

See Appendix A for a tutorial on creating a configuration file.

Note: The configuration file for the SPR Host must be named **HOST.CFG** and it must be in the same directory as the SPR Host program.

4. Delete the old files by typing **RESET electionname** at C:\SPR.

Note: If you need to retain a previous election which has the same name as the new election, save the previous election to a new name or to diskette first before performing the reset.

5. Create the precinct list using your ES&S Hardware Programming Manager program. Refer to your Hardware Programming Manager Operations Manual.
6. If necessary, use the DOS text editor to modify the precinct list.

To test a new configuration, enter **HOST** from the C:\SPR sub-directory to start the host operation. The program will create the precinct SPR files as it begins running. After successful initialization, a screen similar to the one shown below will display with the Modem Status/Control window highlighted.

Smart Pack Reader (Host 1)		(c)1998 Election Systems & Software			
Election Info					
Election: WYOTEST					
Communications Status					
CH	STATUS	ON-LINE	SITE/DISTRICT	BAUD	MODE
1	Enabled	Connected		9600	MODEM
2	Enabled	Connected		9600	MODEM
3	Enabled	Connected		9600	MODEM
					PACKS
					0
					0
					0
					09:27:53
Command/Message					
Modem Status/Control					
CHANNEL: 3 Modem OK					
TAB Next Window F3 Quit F5 Dial F7 Disable/Enable F9 Hangup F10 Send					
FB Phones Shift-Fn=1-10, Ctrl-Fn=11-16, etc. Select Channel Message					

After successful startup, use F3 to exit to DOS. If startup fails, re-check the configuration parameters.

The following items are defined in the configuration file.

- ELECTION** Enter the election specific file name.
- DEVICE** Set the number of serial ports to be used (1-8 is acceptable). Set the IRQ number for this serial port device. Set the port parameters: baud rate, character size, parity (N), stop bits (2), handshake, and mode (either local or modem).
- SITE** Set the name of this SPR Host unit. If there are multiple host units, use a number from 0 to 9 to identify multiple host PC's running in the same election.
- DISPLAY** Set the display for HIGH to display 43 lines on the screen or LOW to display 25 lines on the screen and specify whether to use color.
- PHONE** Set the telephone line mode for tone, pulse, or leased. Set the default phone number.
- ACCESS** Set the system-wide password (8 characters) that will be utilized by ALL remote sending units calling in to the SPR Host.
- PACK** Set the type of packs to be used: DUMMY, OPII, OPIII-P, EAGLE, or PBC2100). The PACKREADMODE controls how many packs can be queued at a time (one or many). The PACKIMAGE saves the image of the pack. If COMPRESS is used, the image will be compressed.
- SERVERPATH** Set the sub-directory where the SPR Host and remote sending units will put packs for Election Reporting Manager.
- HOSTPATH** Set the sub-directory where the SPR Host will put its log file and pack status file.

A sample configuration file for a SPR Host with four serial ports is shown on the next page. In this configuration, the setup consists of one multi-port board having four channels of 16550 UARTS. Three channels will be connected to modems, and one channel will be a direct local hookup.

```
;Setup one multi-port board which has four channels of 16550 UARTS
```

```
; Three will be connected to modems and one will be a direct local  
; hookup
```

```
[ELECTION]
```

```
electionfiles=WYOTEST
```

```
[DEVICE]
```

```
baseaddress=300
```

```
interrupt=5
```

```
portsondevice=9600,8,N,2,HANDSHAKE,MODEM
```

```
portsondevice=9600,8,N,2,HANDSHAKE,MODEM
```

```
portsondevice=9600,8,N,2,HANDSHAKE,MODEM
```

```
portsondevice=9600,8,N,2,HANDSHAKE,local
```

```
[DISPLAY]
```

```
lines=low,color
```

```
; where AERO will expect to find data
```

```
[SERVER]
```

```
serverpath= C:\SPR
```

```
serverpath= !:\SPR
```

```
; where host will put received packs and log file
```

```
[HOST]
```

```
hostpath=C:\SPR
```

```
[SITE]
```

```
hostname=ESS ROCKFORD
```

```
hostunit=1
```

```
[ACCESS]
```

```
password=00005657
```

```
[PHONE]
```

```
dialingmode=TONE
```

```
hostphone=555-1212
```

```
[PACK]
```

```
packtype=EAGLERAM
```

```
packreadmode=MANY
```

```
packimage=SAVE
```

```
packinterface=
```

Setup is one multi-port board which has four channels of 16550 UARTS. Three will be connected to modems and one will be a direct local hookup.

SPR Remote Unit

1. To run the SPR setup program, at the C:\SPR DOS prompt type **SPRSETUP** and press ENTER.
3. Select Get Setup from the menu, and enter **SPR.CFG** to load the SPR remote's configuration file. Then make any necessary changes to the file.
4. After all of the required changes have been made, select Save Setup from the main menu, and save the setup as **SPR.CFG**.

See Appendix D for a tutorial on creating a configuration file.

Note: The configuration file for the SPR Remote must be named **SPR.CFG** and it must be in the same directory as the SPR Remote program.

5. Delete the old files by typing **RESET *electionname*** at C:\SPR.

Note: If you need to retain a previous election which has the same name as the new election, save the previous election to a new name or to diskette first before performing the reset.

6. To test a new configuration, enter **SPR** from the C:\SPR sub-directory to start the operation. After successful startup, press F3 to exit to DOS. If the startup fails, re-check the configuration file.

The following items are defined in the configuration file.

- ELECTION** Enter the election specific file name.
- DEVICE** Set the number of serial ports to be used (1 is the appropriate setting for the remote). Set the IRQ number for this serial port device. Set the port parameters: baud rate, character size, parity, stop bits, handshake, and mode (either local or modem).
- SITE** Set the district number (used to get a list of all precincts expected to be sent from this location) and the district name to identify the site. Set the sprunit number (for station in READERONLY mode).
- DISPLAY** Set the display for HIGH to display 43 lines on the screen or LOW to display 25 lines on the screen and specify whether to use color.
- PHONE** Set the telephone line mode for tone, pulse, or leased. Set the default Host phone number.
- ACCESS** Set the system-wide password (8 characters) that will be utilized by all remote sending units calling in to the SPR Host.
- PACK** Set the type of packs to be used: OPII, OPIII-P, Eagle, or PBC4). The PACKREADMODE controls whether more than one pack can be read at a time and stored on disk to be sent to the SPR Host. The PACKIMAGE saves the image of the pack. If COMPRESS is used, the image will be compressed.
- SERVERPATH** Set the sub-directory where the SPR Host and remote sending units will put packs for Election Reporting Manager.
- HOSTPATH** Set the sub-directory where the SPR will put its log file and pack status file.
- PRODUCT** Selects the mode of SPR operation: Readeronly (WAN is not yet implemented).

A sample configuration file for an SPR Remote is shown on the next page. In this configuration, the setup consists of the SPR using COM1.

[ELECTION]
electionfiles=WYOTEST

;com1 on pc

[DEVICE]
baseaddress=3F8
interrupt=4
portsondevice=1
port=9600,8,N,2,HANDSHAKE,MODEM

[DISPLAY]
lines=low,color

[SERVER]
serverpath=C:\SPR

[HOST]
hostpath=C:\SPR

[SITE]
district=0001
districtname=TEST SITE
sprunit=01

[ACCESS]
password=00005657

[PHONE]
dialingmode=TONE
hostphone=18005551212

[PACK]
packtype=EAGLERAM
packreadmode=MANY
packimage=SAVE

[PRODUCT]
readeronly=NO

Setup is for remote
SPR unit with
modem on COM1.

Chapter 6: Acquisition Manager Operation

SPR Host

Setting up the Data Acquisition Manager

1. Open the SPR host unit and remove the power cord and the phone cord from the black pouch next to the screen.
2. Plug one end of the power cord into an outlet and the other end into the right hand side of the SPR HOST.
3. Plug one end of the phone cord into the wall phone jack and the other end into the phone jack on the top of the SPR HOST.
4. Power ON by pressing the switch on the right side of the machine.

Running the Software

When you turn the power ON, the ES&S menu will display. Choose F1 to run the Host program. (If the menu doesn't display, type HOST at the C:\SPR prompt. The authorization screen displays.

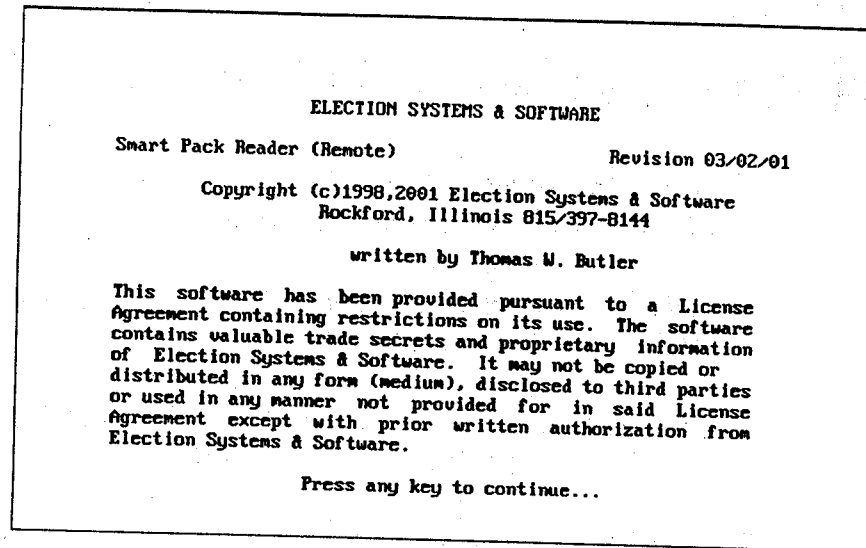

1. Press ENTER. A screen like the one shown below will display after a few seconds.

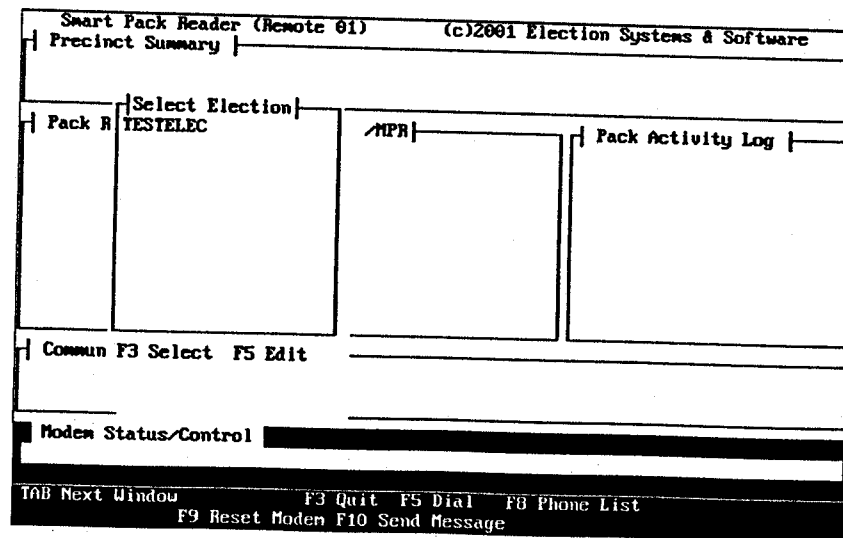

3. Press Tab to go to the Precinct Pack Status window. Your screen will look like the one shown below.

Smart Pack Reader (Host 1)		(c)2001 Election Systems & Software	
Election Info		Election:TESTELEC 0 received of 1000 (0%)	
Precinct Pack Status - Received			
PAGE: 1 of 63 SPR:0000 PRECINCTS:1000 RD=Read SE=Sent			
Command/Message			
Modem Status/Control			
Modem not connected or power to modem is not on. Setting for LOCAL connection.			
Tab Next Window F3 Quit F5 Full List F6 Packs to Read F7 Sent/Received F4 List for SPR F8 Wide/Narrow Display Format F9 Create Status List			

The keys used on this screen and their functions are shown below.

- Tab Go to next window
 - F3 Quit
 - F4 SPR number for precinct list (0000 for all SPR's)
 - F5 Full list of precinct packs and the status of each
 - F6 List of packs to read
 - F7 List of packs received
 - F8 Wide/narrow display
 - F9 Create Precinct Status List
4. Press F9 to create the **Precinct Status List**. Press F9 again to confirm that you want to build this list. The system then creates **electionname.SPS**, the precinct status file.

5. Load the newly created list by pressing F4. Then enter 0000 to load all SPR districts. The system is now ready to accept data. A screen similar to the one shown below displays in the wide display format.

```

Smart Pack Reader (Host 1)          (c)2001 Election Systems & Software
| Election Info |
| Election:TESTELEC  0 received of 1000 ( 0%) |
|-----|
| Precinct Pack Status |
PAGE: 1 of 63  SPR:0000  PRECINCTS:1000  RD=Read SE=Sent
0001!  !TEST PRECINCT # 1      0009!  !ABSENTEE VOTERS
0002!  !TEST PRECINCT # 2      0010!  !ABSENTEE VOTERS
0003!  !TEST PRECINCT # 3      0011!  !ABSENTEE VOTERS
0004!  !TEST PRECINCT # 4      0012!  !ABSENTEE VOTERS
0005!  !TEST PRECINCT #5      0013!  !ABSENTEE VOTERS
0006!  !ABSENTEE VOTERS        0014!  !ABSENTEE VOTERS
0007!  !ABSENTEE VOTERS        0015!  !ABSENTEE VOTERS
0008!  !ABSENTEE VOTERS        0016!  !ABSENTEE VOTERS
|-----|
| Command/Message |
|-----|
| Modem Status/Control |
Modem not connected or power to modem is not on.
Setting for LOCAL connection.
|-----|
TAB Next Window  F3 Quit  F5 Full List  F6 Packs to Read  F7 Sent/Received
F4 List for SPR  F8 Wide/Narrow Display Format  F9 Create Status List

```

If you press F8, the screen will display in the narrow mode.

```

Smart Pack Reader (Host 1)          (c)2001 Election Systems & Software
| Election Info |
| Election:TESTELEC  0 received of 1000 ( 0%) |
|-----|
| Precinct Pack Status |
PAGE: 1 of 21  SPR:0000  PRECINCTS:1000  RD=Read SE=Sent
0001!  0009!  0017!  0025!  0033!  0041!
0002!  0010!  0018!  0026!  0034!  0042!
0003!  0011!  0019!  0027!  0035!  0043!
0004!  0012!  0020!  0028!  0036!  0044!
0005!  0013!  0021!  0029!  0037!  0045!
0006!  0014!  0022!  0030!  0038!  0046!
0007!  0015!  0023!  0031!  0039!  0047!
0008!  0016!  0024!  0032!  0040!  0048!
|-----|
| Command/Message |
|-----|
| Modem Status/Control |
Modem not connected or power to modem is not on.
Setting for LOCAL connection.
|-----|
TAB Next Window  F3 Quit  F5 Full List  F6 Packs to Read  F7 Sent/Received
F4 List for SPR  F8 Wide/Narrow Display Format  F9 Create Status List

```

If you set the configuration file item for *display=HIGH*, your screen will look like the one shown on the next page with 43 lines of data in narrow display format.

Smart Pack Reader (Host 1)		(c)2001 Election Systems & Software	
Election Info		Election:TESTELEC	
		0 received of 1000 (0%)	
Precinct Pack Status			
PAGE: 1 of 20		SPR:0000 PRECINCTS:1000	
		RD-Read SE-Sent	
0001	ITEST PRECINCT # 1	0027	ABSENTEE VOTERS
0002	ITEST PRECINCT # 2	0028	ABSENTEE VOTERS
0003	ITEST PRECINCT # 3	0029	ABSENTEE VOTERS
0004	ITEST PRECINCT # 4	0030	ABSENTEE VOTERS
0005	ITEST PRECINCT #5	0031	ABSENTEE VOTERS
0006	ABSENTEE VOTERS	0032	ABSENTEE VOTERS
0007	ABSENTEE VOTERS	0033	ABSENTEE VOTERS
0008	ABSENTEE VOTERS	0034	ABSENTEE VOTERS
0009	ABSENTEE VOTERS	0035	ABSENTEE VOTERS
0010	ABSENTEE VOTERS	0036	ABSENTEE VOTERS
0011	ABSENTEE VOTERS	0037	ABSENTEE VOTERS
0012	ABSENTEE VOTERS	0038	ABSENTEE VOTERS
0013	ABSENTEE VOTERS	0039	ABSENTEE VOTERS
0014	ABSENTEE VOTERS	0040	ABSENTEE VOTERS
0015	ABSENTEE VOTERS	0041	ABSENTEE VOTERS
0016	ABSENTEE VOTERS	0042	ABSENTEE VOTERS
0017	ABSENTEE VOTERS	0043	ABSENTEE VOTERS
0018	ABSENTEE VOTERS	0044	xxxx
0019	ABSENTEE VOTERS	0045	ABSENTEE VOTERS
0020	ABSENTEE VOTERS	0046	ABSENTEE VOTERS
0021	ABSENTEE VOTERS	0047	ABSENTEE VOTERS
0022	ABSENTEE VOTERS	0048	ABSENTEE VOTERS
0023	ABSENTEE VOTERS	0049	ABSENTEE VOTERS
0024	ABSENTEE VOTERS	0050	ABSENTEE VOTERS
0025	ABSENTEE VOTERS	0051	ABSENTEE VOTERS
0026	ABSENTEE VOTERS	0052	ABSENTEE VOTERS

Command/Message	

Modem Status/Control	
CHANNEL= 1	
Modem not connected or power to modem is not on.	
Setting for LOCAL connection.	

TAB Next Window F3 Quit F5 Full List F6 Packs to Read F7 Sent/Received
F4 List for SPR F8 Wide/Narrow Display Format F9 Create Status List

By pressing TAB, you can move among the three windows described on the next pages.

Precinct Pack Status Window

This window must be active when you want to view the status of the precinct packs. When you tab to this window, your screen will look like the one shown below.

Smart Pack Reader (Host 1)		(c)2001 Election Systems & Software	
Election Info			
Election:TESTELEC		0 received of 1000 (.0%)	
Precinct Pack Status			
PAGE: 1 of 63 SPR:0000 PRECINCTS:1000 RD=Read SE=Sent			
0001:	TEST PRECINCT # 1	0009:	ABSENTEE VOTERS
0002:	TEST PRECINCT # 2	0010:	ABSENTEE VOTERS
0003:	TEST PRECINCT # 3	0011:	ABSENTEE VOTERS
0004:	TEST PRECINCT # 4	0012:	ABSENTEE VOTERS
0005:	TEST PRECINCT #5	0013:	ABSENTEE VOTERS
0006:	ABSENTEE VOTERS	0014:	ABSENTEE VOTERS
0007:	ABSENTEE VOTERS	0015:	ABSENTEE VOTERS
0008:	ABSENTEE VOTERS	0016:	ABSENTEE VOTERS
Command/Message			
Modem Status/Control			
Modem not connected or power to modem is not on. Setting for LOCAL connection.			
TAB Next Window F3 Quit F5 Full List F6 Packs to Read F7 Sent/Received F4 List for SPR F8 Wide/Narrow Display Format F9 Create Status List			

The keys used on this screen and their functions are shown below.

- Tab Go to next window
- F3 Quit
- F4 List of precincts for SPR number
- F5 Full list of precinct packs
- F6 List of packs to read
- F7 List of packs received
- F8 Wide/narrow display
- F9 Create status list

Communications Status Window

When you tab to this window, your screen will look like the one below.

Smart Pack Reader (Host 1)		(c)1998 Election Systems & Software					
Election Info							
Election: NYOTEST							
Communications Status							
CH	STATUS	ON-LINE	SITE/DISTRICT	BAUD	MODE	PACKS	09:27:53
1	Enabled	Connected		9600	MODEM	0	
2	Enabled	Connected		9600	MODEM	0	
3	Enabled	Connected		9600	MODEM	0	
Command/Message							
Modem Status/Control							
CHANNEL# 3 Modem OK							
TAB Next Window F3 Quit F5 Dial F7 Disable/Enable F9 Hangup F10 Send							
F8 Phone# Shift-Fn=1-10, Ctrl-Fn=11-16, etc. Select Channel Message							

The keys used on this screen and their functions are shown below.

- Tab Go to next window
- F3 Quit

Modem Status/Control Window

This window must be active when you want to send a message to the remote site. When you TAB to this window, your screen will look like the one below. Notice that the previous modem activity will always display in this window.

Smart Pack Reader (Host 1)		(c)2001 Election Systems & Software					
Election Info							
Election: TESTELEC							
Communications Status							
CH	STATUS	ON-LINE	SITE/DISTRICT	BAUD	MODE	PACKS	08:51:22
1	Enabled	Noconnect		9600	LOCAL	0	
Command/Message							
Modem Status/Control							
Modem not connected or power to modem is not on.							
Setting for LOCAL connection.							
TAB Next Window		F3 Quit	F5 Dial	F7 Disable/Enable	F9 Hangup	F10 Send	
F8 Phone#		Shift-Fn=1-10, Ctrl-Fn=11-16, etc. Select Channel				Message	

The keys used on this screen and their functions are shown below.

- TAB Go to next window
- F3 Quit
- F5 Dial
- F7 Disable/Enable the modem listed in the modem window
- F8 Phone list
- F9 Hang up
- F10 Send a message to a remote
- CTRL + Fn Select channel

- From the Modem Status/Control window, you can press CTRL + *n* to select a channel and then perform any of the following functions.

To Dial a Remote Site

1. With the correct channel selected, press F8 to display the Phone Numbers list box. The screen will look like the one shown below.

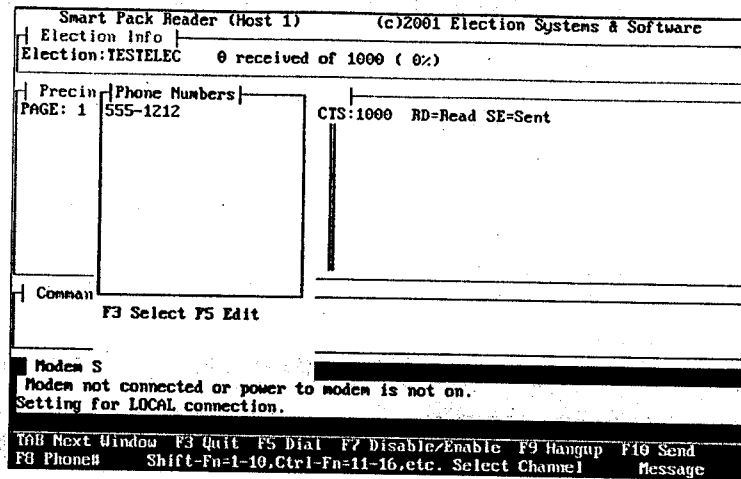

2. Press the DOWN ARROW key to scroll through the list of numbers and highlight the number you want to dial.
3. Press F3 to select the one you have highlighted. That number will now display in the Modem window as the Number Selected to Dial. Press F5 to dial that site.
4. If the number you want is not listed in the Phone Numbers list box, press F5 and then press BACKSPACE repeatedly to go to the beginning of the field.
5. Type the number you need, and press ENTER. That number will now be highlighted on the list.
6. Press F3 to select it. That number will now display in the Modem window as the Number Selected to Dial.
7. Press F5 to dial that site.

To Send a Message

1. With the correct channel selected, press F10 to send a message to that site. *Send Msg* will display in the Modem Status/Control area of the screen.

Smart Pack Header (Host 1)		(c)2001 Election Systems & Software	
Election Info		Election:TESTELEC 0 received of 1000 (0%)	
Precinct Pack Status		PAGE: 1 of 63 SPR:0000 PRECINCTS:1000 RD=Read SE=Sent	
Command/Message			
Modem Status/Control			
Number Selected to Dial: 555-1212			
CH= 1 Send Msg:Type message here.			
TAB Next Window	F3 Quit	F5 Dial	F7 Disable/Enable
F8 Phone#	Shift-Fn=1-10, Ctrl-Fn=11-16, etc.	F9 Hangup	F10 Send Message

2. Type your message into the box (maximum of 44 characters); then press ENTER to send it.

To disable or enable a channel

- With the correct channel selected, press F7 to toggle the selected channel from disabled to enabled, etc.

Configuring the SPR Remote Unit

Machine Setup

1. Open the SPR and remove the power cord and phone cord from the black pouch next to the screen.
2. Plug one end of the power cord into an outlet and the other end into the right hand side of the SPR.
3. Plug one end of the phone cord into the wall jack and the other end into the phone jack on the top of the SPR.
4. Press the switch on the right side of the SPR to turn it ON.

Running the Software

When you turn the power ON, the ES&S menu will display.

1. Choose to run the SPR Remote program. (If the menu doesn't display, type SPR at the C:\SPR prompt.) The authorization screen displays.

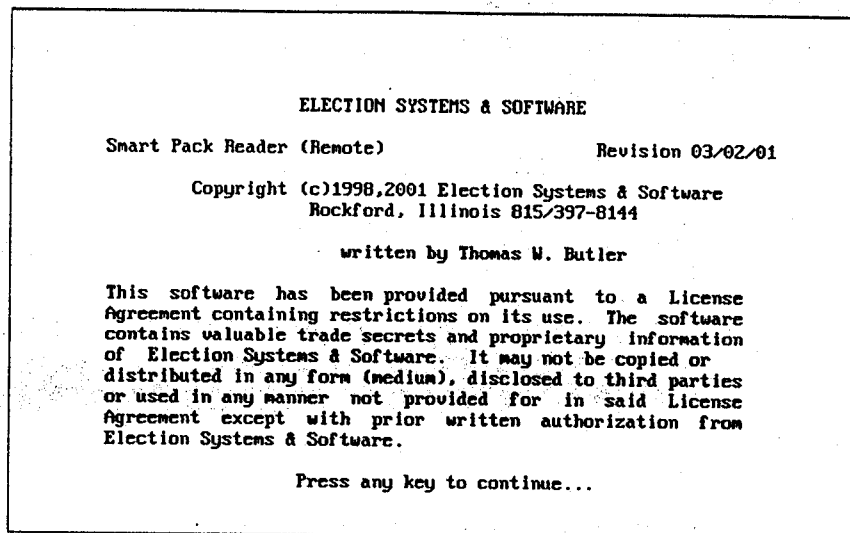

2. Press ENTER. A screen like the one shown below will display after a few seconds.

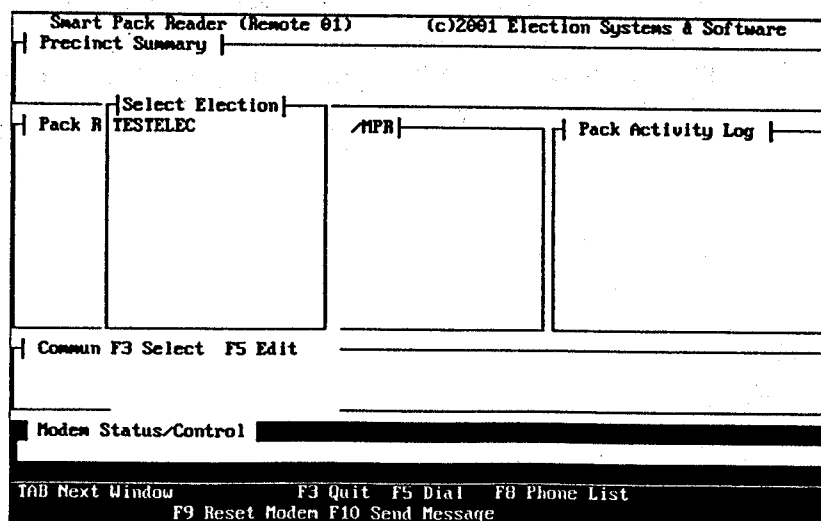

3. Do one of the following:

- Highlight the election name and press F3 to select it. The SPR will then initialize the modem. During initialization, your screen will look like the one shown below.

Smart Pack Reader (Remote 01)		(c)2001 Election Systems & Software	
Precinct Summary			
Pack Type: Eagle Ram	0 Read.	0 sent of 1000 (0%)	3 On Disk To Send
Election: TESTELEC District: 0001 TEST SITE			
Pack Read Control	Pack: Eagle Ram /MPR		Pack Activity Log
Please wait...initializing modem.			
Communications Status			
Modem Status/Control			
Modem not connected or power to modem is not on.			
TAB Next Window		F3 Quit	F5 Dial
		F8 Phone List	
		F9 Reset Modem	F10 Send Message

- To add or change a number on the list, press F5 and then backspace to clear the number that is there. Enter the new number, and press ENTER. The new number will be highlighted. Press F3 to select it. Your screen will look like the one on the next page.
4. Press F5 to dial out and connect with the SPR Host. You will hear a dial tone, dialing sounds, and then a noise that sounds like static. After the connection has been made, the SPR will then log in and a copy of your precinct listing will be downloaded to your SPR. A screen like the one shown on the next page will display.

Smart Pack Reader (Remote 01)		(c)2001 Election Systems & Software	
Precinct Summary			
Pack Type:Eagle Ram		0 Read.	0 sent of 1000 (0%)
Election:TESTELEC District:0001		TEST SITE	
Pack Read Control		Pack:Eagle Ram /MPR	Pack Activity Log
Insert pack into MPR now.			
Communications Status			
STATUS ON-LINE		BAUD	MODE PHONE NUMBER
Enabled Noconnect		9600	Local 13077398634
Modem Status/Control			
Setting for LOCAL connection.			
TAB Next Window		F3 Quit	

The keys used on this screen and their functions are shown below.

- TAB Go to next window
- F3 Quit
- F5 Dial
- F8 Display phone list
- F9 Reset modem
- F10 Send message

The system is now ready to read packs.

Note: The keys used on each screen vary depending on the screen selected.

5. Press TAB to go to the Pack Read Control screen. It will look similar to the one shown on the next page.

Smart Pack Reader (Remote 01)		(c)1991 Election Systems & Software	
Precinct Summary			
Pack Type:	Eagle Ram	0 Read.	0 sent of 1000 (0%) 3 On Disk To Send
Election:TESTELEC District:0001 TEST SITE			
Pack Read Control		Pack:Eagle Ram /MPR	Pack Activity Log
Insert pack into MPR now.			
Communications Status			
STATUS	ON-LINE	BAUD	MODE PHONE NUMBER
Enabled	Noconnect	9600	Local 13077398634
Modem Status/Control			
Setting for LOCAL connection.			
TAB Next Window		F3 Quit	

6. Insert the Pack into the pack fixture, which is located on the top of the SPR by the phone cord.
7. Press ENTER to read in the pack. It will be read automatically and sent to the Host. After the pack is successfully read, the precinct number displays in the Pack Read Control window. The screen will look like the one shown below.

Smart Pack Reader (Remote 01)		(c)1998 Election Systems & Software	
Precinct Summary			
Pack Type:	Eagle Ram	1 Read	1 sent of 12 (20%) 0 On Disk To Send
Election: WYOTEST District: WYOMING			
Pack Read Control		Pack:Eagle Ram /IDA	Pack Activity Log
Precinct 0001-Successfully Read		16-13-12 PREC 0001 READ	
Press any key to continue.		16-13-15 PREC 0002 SENT	
Communications Status			
STATUS	ON-LINE	BAUD	MODE PHONE NUMBER
Enabled	Noconnect	9600	Local 555-1212
Modem Status/Control			
Setting for LOCAL connection.			
TAB Next Window		F3 Quit F5 Dial F8 Phone List	
F9 Reset Modem F10 Send Message			

The keys used on this screen and their functions are shown below.

- TAB Go to next window
 - F3 Quit
 - F5 Dial
 - F8 Display phone list
 - F9 Reset modem
 - F10 Send message
8. Remove the pack, and press ENTER to ready the SPR for reading another pack.
 9. After all packs have been read in and you have received permission to quit, press F3 to quit and then F3 again to confirm it.
 10. Turn the power OFF. Then disconnect the power cord and the modem cord. Place them in the black pouch next to the screen for storage.

View Packs Read and Sent (Full List)

To view the progress of packs read and sent from the SPR remote sending unit, press TAB until the Precinct Pack Status window displays. Press F5 to view the status of all packs.

```

Smart Pack Reader (Remote 01) (c)2001 Election Systems & Software
Precinct Summary
Pack Type:Eagle Ram 0 Read. 0 sent of 1000 ( 0%) 3 On Disk To Send
Election:TESTELEC District:0001 TEST SITE

Precinct Pack Status - Full List
PAGE: 1 of 63 SPR:0001 PRECINCTS:1000 RD=Read SE=Sent
0001: TEST PRECINCT # 1 0009: ABSENTEE VOTERS
0002: TEST PRECINCT # 2 0010: ABSENTEE VOTERS
0003: TEST PRECINCT # 3 0011: ABSENTEE VOTERS
0004: TEST PRECINCT # 4 0012: ABSENTEE VOTERS
0005: TEST PRECINCT #5 0013: ABSENTEE VOTERS
0006: ABSENTEE VOTERS 0014: ABSENTEE VOTERS
0007: ABSENTEE VOTERS 0015: ABSENTEE VOTERS
0008: ABSENTEE VOTERS 0016: ABSENTEE VOTERS

Communications Status
STATUS ON-LINE
Enabled Connected BAUD MODE PHONE NUMBER
9600 Modem 555-1212

Modem Status/Control
Logged in to host: 1 ESS Rockford

TAB Next Window F3 Quit F5 Full List F6 Packs to Read
F7 Packs Sent F8 Wide/Narrow Display Format
    
```

By pressing F8 you can toggle back and forth between the wide display above and the narrow display below.

```

Smart Pack Reader (Remote 01) (c)2001 Election Systems & Software
Precinct Summary
Pack Type:Eagle Ram 0 Read. 0 sent of 1000 ( 0%) 3 On Disk To Send
Election:TESTELEC District:0001 TEST SITE

Precinct Pack Status
PAGE: 1 of 21 SPR:0001 PRECINCTS:1000 RD=Read SE=Sent
0001: 0009: 0017: 0025: 0033: 0041:
0002: 0010: 0018: 0026: 0034: 0042:
0003: 0011: 0019: 0027: 0035: 0043:
0004: 0012: 0020: 0028: 0036: 0044:
0005: 0013: 0021: 0029: 0037: 0045:
0006: 0014: 0022: 0030: 0038: 0046:
0007: 0015: 0023: 0031: 0039: 0047:
0008: 0016: 0024: 0032: 0040: 0048:

Communications Status
STATUS ON-LINE
Enabled Noconnect BAUD MODE PHONE NUMBER
9600 Local 13077398634

Modem Status/Control
Logged in to host: 1 ESS Rockford

TAB Next Window F3 Quit F5 Full List F6 Packs to Read
F7 Packs Sent F8 Wide/Narrow Display Format
    
```

View Packs Sent

To view only the packs that have been sent, press F7. The screen will look similar to the one shown below.

Smart Pack Reader (Remote 01)		(c)1998 Election Systems & Software	
Precinct Summary			
Pack Type: Eagle Ram 10 Read. 10 sent of 12 (0%) 0 On Disk To Send			
Election: WYOTEST District:0001 WYOMING			
Precinct Pack Status - Sent			
PAGE: 1 of 1		SPR:0000	PRECINCTS: 12 RD=Read SE=Sent
0001: RD SE	0009: RD SE		
0002: RD SE	0010: RD SE		
0003: RD SE			
0004: RD SE			
0005: RD SE			
0006: RD SE			
0007: RD SE			
0008: RD SE			
Communications Status			
STATUS ON-LINE		BAUD	MODE PHONE NUMBER
Enabled Connected		9600	Modem 555-1212
Modem Status/Control			
Logged in to host: 1 ESS Rockford			
TAB Next Window		F3 Quit	F5 Full List F6 Packs to Read
		F7 Packs Sent	F8 Wide/Narrow Display Format

The keys used on this screen and their functions are shown below.

- TAB Go to next window
- F3 Quit
- F5 Full list and the status of each
- F6 Packs to read
- F7 Packs sent
- F8 Wide/narrow display

By pressing F8 you can toggle back and forth between the wide display above and the narrow display like the one on the previous page.

View Packs to Read

To view only the packs that still need to be read, press F6. The screen will look like the one shown below.

Smart Pack Reader (Remote 01)		(c)1998 Election Systems & Software	
Precinct Summary			
Pack Type: Eagle Ram 10 Read. 10 sent of 12 (0%) 0 On Disk To Send-			
Election: WYOTEST District:0001 WYOMING			
Precinct Pack Status - To Read			
PAGE: 1 of 1 SPR:0001 PRECINCTS: 0 RD=Read SE=Sent			
0011:	:WARD4	PRECINCT 2	
0012:	:WARD4	PRECINCT 3	
Communications Status			
STATUS ON-LINE		BAUD	MODE PHONE NUMBER
Enabled Connected		9600	Modem 555-1212
Modem Status/Control			
Logged in to host: 1 ESS Rockford			
TAB Next Window		F3 Quit	F5 Full List F6 Packs to Read
		F7 Packs Sent	F8 Wide/Narrow Display Format

The keys used on these screens and their functions are shown below.

- TAB Go to next window
- Shift+TAB Go to previous window.
- F3 Quit
- F5 Full list of packs and the status of each
- F6 Packs to read
- F7 Packs sent
- F8 Wide/narrow display

By pressing F8 you can toggle back and forth between the wide display and the narrow display.

By using the TAB key, you can move among the three windows described on the next pages.

Pack Read Control Window

This window must be active when you want to insert and read in packs. When you TAB to this window, your screen will look like the one below.

Smart Pack Reader (Remote 01)		(c)1998 Election Systems & Software	
Precinct Summary			
Pack Type:	Eagle Ram	1 Read	1 sent of 12 (20%) 0 On Disk To Send
Election:	WYOTEST	District:	WYOMING
Pack Read Control		Pack: Eagle Ram /IDA	Pack Activity Log
Precinct 0001-Successfully Read		16:13:12 PREC0001 READ	
Press any key to continue.		16:13:15 PREC0002 SENT	
Communications Status			
STATUS ON-LINE		BAUD	MODE PHONE NUMBER
Enabled Connected		9600	Modem 555-1212
Modem Status/Control			
Logged in to host: 1 ESS Rockford			
TAB Next Window		F3 Quit	

The keys used on this screen and their functions are shown below.

- TAB Go to next window
- F3 Quit

Precinct Pack Status Window

This window must be active when you want to view the status of the precinct packs. When you TAB to this window, your screen will look like the one below.

Smart Pack Reader (Remote 01)		(c)1998 Election Systems & Software	
Precinct Summary			
Pack Type: Eagle Ram	0 Read.	0 sent of	12 (0%) 0 On Disk To Send
Election: WYOTEST District:0001 WYOMING			
Precinct Pack Status			
PAGE: 1 of 1 SPR:0001 PRECINCTS: 12 RD=Read SE=Sent			
0001:	:WARD 1 PRECINCT 1	0012:RD SE:WARD 4 PRECINCT 3	
0002:	:WARD 1 PRECINCT 2		
0003:	:WARD 1 PRECINCT 3		
0004:	:WARD 2 PRECINCT 1		
0005:	:WARD 2 PRECINCT 2		
0006:	:WARD 2 PRECINCT 3		
0007:	:WARD 3 PRECINCT 1		
0008:	:WARD 3 PRECINCT 2		
0009:	:WARD 3 PRECINCT 3		
0010:	:WARD 4 PRECINCT 1		
0011:RD SE:	:WARD 4 PRECINCT 2		
Communications Status			
STATUS ON-LINE		BAUD	MODE PHONE NUMBER
Enabled Connected		9600	Modem 555-1212
Modem Status/Control			
Setting for LOCAL			
TAB Next Window		F3 Quit	F5 Full List F6 Packs to Read
		F7 Packs Sent	F8 Wide/Narrow Display Format

The keys used on this screen and their functions are shown below.

- TAB Go to next window
- F3 Quit
- F5 Full list of packs and the status of each
- F6 List of packs to read
- F7 List of packs sent
- F8 Wide/narrow display

Modem Status/Control Window

This window must be active when you want to send a message to the host. When you TAB to this window, your screen will look like the one below. Notice that the previous modem activity will always display in this window.

Smart Pack Reader (Remote 01)		(c)1998 Election Systems & Software	
Precinct Summary			
Pack Type:	Eagle Ram	0 Read.	0 sent of 12 (0%) 0 On Disk To Send
Election: WYOTEST District:0001 WYOMING			
Precinct Pack Status			
PAGE: 1 of 1	SPR:0001	PRECINCTS: 12	RD=Read SE=Sent
0001:	:WARD 1	PRECINCT 1	0012 :WARD 4 PRECINCT 3
0002:	:WARD 1	PRECINCT 2	
0003:	:WARD 1	PRECINCT 3	
0004:	:WARD 2	PRECINCT 1	
0005:	:WARD 2	PRECINCT 2	
0006:	:WARD 2	PRECINCT 3	
0007:	:WARD 3	PRECINCT 1	
0008:	:WARD 3	PRECINCT 2	
0009:	:WARD 3	PRECINCT 3	
0010:	:WARD 4	PRECINCT 1	
0011:	:WARD 4	PRECINCT 2	
Communications Status			
STATUS	ON-LINE	BAUD	MODE PHONE NUMBER
Enabled	Noconnect	9600	Local 1
Modem Status/Control			
Setting for LOCAL connection.			
TAB Next Window F3 Quit F5 Dial F8 Phone List			
F9 Reset Modem F10 Send Message			

The keys used on this screen and their functions are shown below.

- TAB Go to next window
- F3 Quit
- F5 Dial
- F8 Phone list
- F9 Reset modem
- F10 Send a message

From the Modem Status/Control window, you can perform any of the functions described on the next pages.

To Dial the Host

1. Press F8 to display the Phone Numbers list box. The screen will look like the one shown below.

Smart Pack Reader (Remote 01)		(c)2001 Election Systems & Software	
Precinct Summary		Pack Type: Eagle Ram 0 Read. 0 sent of 1000 (0%) 3 On Disk To Send	
Election: TESTELEC District: 0001 TEST SITE			
Phone Numbers			
Precin	13077398634 555-1212		
		SE=Sent NTEE VOTERS NTEE VOTERS NTEE VOTERS NTEE VOTERS NTEE VOTERS NTEE VOTERS NTEE VOTERS	
Comm F3 Select F5 Edit		BAUD MODE PHONE NUMBER	
STATUS Enabled		9600 Local 13077398634	
Modem Status/Control			
Reset command sent to modem.			
TAB Next Window F3 Quit F5 Dial F8 Phone List F9 Reset Modem F10 Send Message			

2. Press the DOWN ARROW key to scroll through the list of numbers and highlight the one you want to dial.
3. Press F3 to select the one you have highlighted. That number will now display in the Modem Status/Control window as the Number Selected to Dial.
4. Press F5 to dial that number.
5. If the number you want is not listed in the Phone Numbers list box, press F5 and then BACKSPACE repeatedly to go to the beginning of the field. Type the number you need, and press ENTER. That number will now be highlighted on the list.
6. Press F3 to select it. That number will now display in the Modem window as the Number Selected to Dial.
7. Press F5 to dial that number.

To Send a Message

1. Press F10 to send a message to the host. The message box will display on the screen.

Smart Pack Reader (Remote 01)		(c)1998 Election Systems & Software	
Precinct Summary			
Pack Type: Eagle Ram	0 Read.	0 sent of 12 (0%)	0 On Disk To Send
Election: WYOTEST District:0001 WYOMING			
P Enter message: Type your message here.			
PAG			
Communications Status			
STATUS ON-LINE	BAUD	MODE	PHONE NUMBER
Enabled Noconnect	9600	Local	555-1212
Modem Status/Control			
Number Selected to Dial: 555-1212			
TAB Next Window		F3 Quit F5 Dial F8 Phone List	
F9 Reset Modem F10 Send Message			

2. Type your message into the box (maximum of 44 characters); then press ENTER to send it.

To Reset the Modem

- Press F9.

Configuring a Local SPR Unit

A local data pack reader consists of a PC with an internal ES&S designed pack reading device installed.

1. Be sure that the RS-232 cable is connected to the COM connector on the local SPR unit.

Note: You must use an ES&S *Full Handshake Null Modem* adapter on the Host RS - 232 cable. See Appendix B for a diagram of the *Full Handshake Null Modem* adapter.

2. To run the program, type SPR at C:\SPR.

Note: Occasionally the SPR unit may not connect with the SPR Host immediately. If that is the case, the message *Attempting login to HOST* displays repeatedly. On the SPR Host, press TAB to go to the Modem Status/Control window and the press CTRL + Fn to select a channel (for example, press CTRL + F3). On the SPR Host, press F9 to hang up and reset the channel. If a connection still has not been made, press TAB on the SPR local sending unit to reset it. You could also disconnect the cable from the *Full Handshake Null Modem* adapter, and wait five seconds and then reconnect.

The SPR local sending unit will connect and the Precinct List will be downloaded from the SPR Host automatically. Your screen will look like the one shown below with Modem Status/Control as the active window.

Smart Pack Reader (Remote 01)		(c)2001 Election Systems & Software	
Precinct Summary			
Pack Type: Eagle Ram	0 Read.	0 sent of 1000 (0%)	3 On Disk To Send
Election: TESTELEC District: 0001 TEST SITE			
Pack Read Control		Pack: Eagle Ram /MPR	Pack activity Log
Insert pack into MPR now.			
Communications Status			
STATUS ON-LINE		BAUD	MODE PHONE NUMBER
Enabled Noconnect		9600	Local 13077398634
Modem Status/Control			
Setting for LOCAL connection.			
TAB Next Window			
F3 Quit F5 Dial F8 Phone List			
F9 Reset Modem F10 Send Message			

The keys used on this screen and their functions are shown below.

- TAB Go to next window
- F3 Quit
- F5 Dial the number in the Modem/Status Control window
- F8 Display the phone list
- F9 Reset modem
- F10 Send a message

Note: The keys used on each screen vary depending on the screen selected.

3. After the list has been received, press TAB to go to the Pack Read Control window, which will look like the screen below. The system is now ready to read the Packs.

Smart Pack Reader (Remote 01)		(c)2001 Election Systems & Software	
Precinct Summary			
Pack Type:Eagle Ram 0 Read. 0 sent of 1000 (0%) 3 On Disk To Send			
Election:TESTELEC District:0001 TEST SITE			
Pack Read Control		Pack:Eagle Ram /MPR	Pack Activity Log
Insert pack into MPR now.			
Communications Status			
STATUS ON-LINE		BAUD	MODE PHONE NUMBER
Enabled Noconnect		9600	Local 13077398634
Modem Status/Control			
Setting for LOCAL connection.			
TAB Next Window		F3 Quit	

The keys used on this screen and their functions are shown below.

- TAB Go to next window
 - F3 Quit
4. Insert the Data Pack into the pack fixture located on the top of the machine by the phone cord, and press ENTER to read in the Data Pack. After the pack is successfully read, the precinct number displays in the Pack Read Control window. The screen will look like the one shown on the next page.

Smart Pack Reader (Remote 01)		(c)1998 Election Systems & Software	
Precinct Summary			
Pack Type: Eagle Ram	1 Read	1 sent of 12 (20%)	0 On Disk To Send
Election: WYOTEST District:		WYOMING	
Pack Read Control Pack: Eagle Ram /IDA		Pack Activity Log	
Precinct 0001-Successfully Read Press any key to continue.		16-13-12 PREC 0001 READ	
		16-13-15 PREC 0002 SENT	
Communications Status			
STATUS ON-LINE		BAUD	MODE PHONE NUMBER
Enabled Noconnect		9600	Local 555-1212
Modem Status/Control			
Setting for LOCAL connection.			
TAB Next Window			
F3 Quit		F5 Dial F8 Phone List	
F9 Reset Modem		F10 Send Message	

5. After the local SPR sending unit transmits the pack to the SPR Host, the message *Pack Sent* will display in the Pack Read Control window. After a successful read, the message *Pack Read* will display in the Pack Read Control window.
6. Using one hand to stabilize the SPR unit, remove the Data Pack by gently rocking the pack while firmly pulling up on the Data Pack.
7. After all packs have been read in and you have received permission to quit, press F3 to quit and then F3 again to confirm it.
8. Turn the SPR OFF. Then disconnect the power cord and the modem cord. Place them in the black pouch next to the screen for storage.
9. If an internal modem is installed, unplug the modem wire from the SPR unit and close the SPR case for return to storage.

View Packs Read and Sent (Full List)

To view the progress of packs read and sent from the SPR remote sending unit, press TAB until the Precinct Pack Status window displays. Press F5 to view the status of all packs.

Smart Pack Reader (Remote 01)		(c)2001 Election Systems & Software	
Precinct Summary			
Pack Type:Eagle Ram 0 Read. 0 sent of 1000 (0%) 3 On Disk To Send			
Election:TESTELEC District:0001 TEST SITE			
Precinct Pack Status - Full List			
PAGE: 1 of 63 SPR:0001 PRECINCTS:1000 RD=Read SE=Sent			
0001!	!TEST PRECINCT # 1	0009!	!ABSENTEE VOTERS
0002!	!TEST PRECINCT # 2	0010!	!ABSENTEE VOTERS
0003!	!TEST PRECINCT # 3	0011!	!ABSENTEE VOTERS
0004!	!TEST PRECINCT # 4	0012!	!ABSENTEE VOTERS
0005!	!TEST PRECINCT #5	0013!	!ABSENTEE VOTERS
0006!	!ABSENTEE VOTERS	0014!	!ABSENTEE VOTERS
0007!	!ABSENTEE VOTERS	0015!	!ABSENTEE VOTERS
0008!	!ABSENTEE VOTERS	0016!	!ABSENTEE VOTERS
Communications Status			
STATUS ON-LINE		BAUD	MODE PHONE NUMBER
Enabled Noconnect		9600	Local 13077398634
Modem Status/Control			
Setting for LOCAL connection.			
TAB Next Window F3 Quit F5 Full List F6 Packs to Read			
F7 Packs Sent F8 Wide/Narrow Display Format			

By pressing F8 you can toggle back and forth between the wide display above and the narrow display below.

Smart Pack Reader (Remote 01)		(c)2001 Election Systems & Software	
Precinct Summary			
Pack Type:Eagle Ram 0 Read. 0 sent of 1000 (0%) 3 On Disk To Send			
Election:TESTELEC District:0001 TEST SITE			
Precinct Pack Status			
PAGE: 1 of 21 SPR:0001 PRECINCTS:1000 RD=Read SE=Sent			
0001!	0009!	0017!	0025!
0002!	0010!	0018!	0026!
0003!	0011!	0019!	0027!
0004!	0012!	0020!	0028!
0005!	0013!	0021!	0029!
0006!	0014!	0022!	0030!
0007!	0015!	0023!	0031!
0008!	0016!	0024!	0032!
0033!	0041!	0042!	0043!
0034!	0044!	0045!	0046!
0035!	0047!	0048!	
0036!			
0037!			
0038!			
0039!			
0040!			
Communications Status			
STATUS ON-LINE		BAUD	MODE PHONE NUMBER
Enabled Noconnect		9600	Local 13077398634
Modem Status/Control			
Setting for LOCAL connection.			
TAB Next Window F3 Quit F5 Full List F6 Packs to Read			
F7 Packs Sent F8 Wide/Narrow Display Format			

View Packs Sent

To view only the packs that have been sent, press F7. The screen will look like the one shown below.

Smart Pack Reader (Remote 01)		(c)1998 Election Systems & Software	
Precinct Summary			
Pack Type: Eagle Ram	2 Read.	2 sent of 12 (0%)	0 On Disk To Send -
Election: WYOTEST District:0001 WYOMING			
Precinct Pack Status - Sent			
PAGE: 1 of 1	SPR:0001	PRECINCTS: 0	RD=Read SE=Sent
0009:RD SE			
0010:RD SE			
Communications Status			
STATUS ON-LINE		BAUD	MODE PHONE NUMBER
Enabled Noconnect		9600	Local 1
Modem Status/Control			
Setting for LOCAL connection.			
TAB Next Window		F3 Quit	F5 Full List
		F6 Packs to Read	F7 Packs Sent
		F8 Wide/Narrow Display Format	

The keys used on this screen and their functions are shown below.

- TAB Go to next window
- F3 Quit
- F5 Display the full list
- F6 Display packs to be read
- F7 Display Packs sent
- F8 Wide/narrow display

By pressing F8 you can toggle back and forth between the wide display and the narrow display.

View Packs to Read

To view only the packs that still need to be read, press F6. The screen will look like the one shown below.

Smart Pack Reader (Remote 01)		(c)1998 Election Systems & Software	
Precinct Summary			
Pack Type:	Eagle Ram	2 Read.	2 sent of 12 (0%) 0 On Disk To Send
Election: WYOTEST District:0001 WYOMING			
Precinct Pack Status - To Read			
PAGE:	1 of 1	SPR:0001	PRECINCTS: 12 RD=Read SE=Sent
0001:	:WARD 1	PRECINCT 1	
0002:	:WARD 1	PRECINCT 2	
0003:	:WARD 1	PRECINCT 3	
0004:	:WARD 2	PRECINCT 1	
0005:	:WARD 2	PRECINCT 2	
0006:	:WARD 2	PRECINCT 3	
0007:	:WARD 3	PRECINCT 1	
0008:	:WARD 3	PRECINCT 2	
0011:	:WARD 4	PRECINCT 2	
0012:	:WARD 4	PRECINCT 3	
Communications Status			
STATUS	ON-LINE	BAUD	MODE PHONE NUMBER
Enabled	Noconnect	9600	Local 1
Modem Status/Control			
Setting for LOCAL connection.			
TAB Next Window		F3 Quit	F5 Full List F6 Packs to Read
		F7 Packs Sent	F8 Wide/Narrow Display Format

The keys used on these screens and their functions are shown below.

- TAB Go to next window
- Shift +TAB Go to previous
- F3 Quit
- F5 Full list of packs and the status of each
- F6 Packs to read
- F7 Packs sent
- F8 Wide/narrow display

By pressing F8 you can toggle back and forth between the wide display and the narrow display.

By using the TAB key, you can move among the three windows described on the next pages.

Pack Read Control Window

This window must be active when you want to insert and read in packs. When you TAB to this window, your screen will look like the one below.

Smart Pack Reader (Remote 01)		(c)2001 Election Systems & Software	
Precinct Summary			
Pack Type:Eagle Ram	0 Read.	0 sent of 1000 (0%)	3 On Disk To Send
Election:TESTELEC District:0001 TEST SITE			
Pack Read Control		Pack:Eagle Ram /MPR	Pack Activity Log
Insert pack into MPR now.			
Communications Status			
STATUS ON-LINE		BAUD	MODE PHONE NUMBER
Enabled Noconnect		9600	Local 13077398634
Modem Status/Control			
Setting for LOCAL connection.			
TAB Next Window		F3 Quit	

The keys used on this screen and their functions are shown below.

- TAB Go to next window
- F3 Quit

Precinct Pack Status Window

This window must be active when you want to view the status of the precinct packs. When you TAB to this window, your screen will look like the one below.

```

Smart Pack Reader (Remote 01)          (c)1998 Election Systems & Software
Precinct Summary
Pack Type: Eagle Ram   0 Read.   0 sent of  12 ( 0%)   0 On Disk To Send
Election: WYOTEST District:0001 WYOMING

Precinct Pack Status
PAGE: 1 of 1   SPR:0001   PRECINCTS: 12   RD=Read SE=Sent
0001:  :WARD 1  PRECINCT 1   0012:RD SE:WARD 4  PRECINCT 3
0002:  :WARD 1  PRECINCT 2
0003:  :WARD 1  PRECINCT 3
0004:  :WARD 2  PRECINCT 1
0005:  :WARD 2  PRECINCT 2
0006:  :WARD 2  PRECINCT 3
0007:  :WARD 3  PRECINCT 1
0008:  :WARD 3  PRECINCT 2
0009:RD SE:WARD 3  PRECINCT 3
0010:RD SE:WARD 4  PRECINCT 1
0011:RD SE:WARD 4  PRECINCT 2

Communications Status
STATUS ON-LINE          BAUD   MODE   PHONE NUMBER
Enabled Connected      9600   Modem 555-1212

Modem Status/Control
Setting for LOCAL

TAB Next Window      F3 Quit  F5 Full List  F6 Packs to Read
F7 Packs Sent F8 Wide/Narrow Display Format
  
```

The keys used on these screens and their functions are shown below.

- TAB Go to next window
- F3 Quit
- F5 Full list of packs and the status of each
- F6 List of packs to read
- F7 List of packs sent
- F8 Wide/narrow display

By pressing F8 you can toggle back and forth between the wide display and the narrow display.

Modem Status/Control Window

This window must be active when you want to send a message to the host. When you TAB to this window, your screen will look like the one below. Notice that the previous modem activity will always display in this window.

Smart Pack Reader (Remote 01)		(c)1998 Election Systems & Software -	
Precinct Summary			
Pack Type:	Eagle Ram	0 Read.	0 sent of 12 (0%) 0 On Disk To Send
Election: WYOTEST District:0001 WYOMING			
Precinct Pack Status			
PAGE:	1 of 1	SPR:0001	PRECINCTS: 12 RD=Read SE=Sent
0001:	:WARD 1	PRECINCT 1	0012 :WARD 4 PRECINCT 3
0002:	:WARD 1	PRECINCT 2	
0003:	:WARD 1	PRECINCT 3	
0004:	:WARD 2	PRECINCT 1	
0005:	:WARD 2	PRECINCT 2	
0006:	:WARD 2	PRECINCT 3	
0007:	:WARD 3	PRECINCT 1	
0008:	:WARD 3	PRECINCT 2	
0009:	:WARD 3	PRECINCT 3	
0010:	:WARD 4	PRECINCT 1	
0011:	:WARD 4	PRECINCT 2	
Communications Status			
STATUS ON-LINE		BAUD	MODE PHONE NUMBER
Enabled Noconnect		9600	Local 1
Modem Status/Control			
Setting for LOCAL connection.			
TAB Next Window F3 Quit F5 Dial F8 Phone List			
F9 Reset Modem F10 Send Message			

The keys used on this screen and their functions are shown below

- TAB Go to next window
- F3 Quit
- F5 Dial
- F8 Display the phone list
- F9 Reset modem
- F10 Send a message

From the Modem Status/Control window, you can perform any of the functions described on the next pages.

To Dial the Host

1. Press F8 to display the Phone Numbers list box. The screen will look like the one shown below.

Smart Pack Reader (Remote 01)		(c)2001 Election Systems & Software	
Precinct Summary		Pack Type: Eagle Ram 0 Read. 0 sent of 1000 (0%) 3 On Disk To Send	
Election: TESTELEC District: 0001 TEST SITE			
Precin	Phone Numbers		
	13077398634		
	555-1212		
		SE=Sent NTEE VOTERS NTEE VOTERS NTEE VOTERS NTEE VOTERS NTEE VOTERS NTEE VOTERS NTEE VOTERS	
COMMUN F3 Select F5 Edit			
STATUS		BAUD	MODE PHONE NUMBER
Enabled		9600	Local 13077398634
Modem Status/Control			
Reset command sent to modem.			
TAB Next Window F3 Quit F5 Dial F8 Phone List			
F9 Reset Modem F10 Send Message			

2. Press ARROW DOWN to scroll through the list of numbers and highlight the one you want to dial.
3. Press F3 to select the one you have highlighted. That number will now display in the Modem window as the Number Selected to Dial. Press F5 to dial that number.
4. If the number you want is not listed in the Phone Numbers list box, press F5 and then press BACKSPACE repeatedly to go to the beginning of the field. Type the number you need, and press ENTER. That number will now be highlighted on the list.
5. Press F3 to select it. That number will now display in the Modem window as the Number Selected to Dial.
6. Press F5 to dial that number.

To Send a Message

1. Press F10 to send a message to the Host. The message box will display on the screen, which will look like the one shown below.

Smart Pack Reader (Remote 01)		(c)1998 Election Systems & Software	
Precinct Summary			
Pack Type: Eagle Ram	0 Read.	0 sent of 12 (0%)	0 On Disk To Send
Election: WYOTEST District:0001 WYOMING			
P	Enter message: Type your message here.		
PAG			
Communications Status			
STATUS ON-LINE		BAUD	MODE PHONE NUMBER
Enabled Noconnect		9600	Local 555-1212
Modem Status/Control			
Number Selected to Dial: 555-1212			
TAB Next Window			
F3 Quit		F5 Dial	F8 Phone List
F9 Reset Modem		F10 Send Message	

2. Type your message into the box (maximum of 44 characters); then press ENTER to send it.

To Reset the Modem

- Press F9.

Using Acquisition Managers with Modems

Election results may be accumulated from tabulators equipped with modems running at 9600 baud. The system can be configured by attaching a SPR to a Host, either locally by network or remotely by phone line. Alternatively, the system can be configured with stand-alone SPR units that can run the Election Reporting Manager software after all results have been stored.

When the HOST unit detects a ring signal from the phone line, it answers after the second ring. The counter then detects the carrier tones and attempts to link at the 9600 baud rate. As soon as the linkup occurs, the counter begins to transfer the data.

After the data has been transferred, the counter hangs up and the line is available for another incoming counter linkup. The entire process of linkup and transmittal of data takes only about 45 seconds total.

Note: Refer to your Modem Supplement for more information on sending results from the counter/modem unit.

SPR Host Installation

Each SPR Host unit can be equipped with up to 10 serial port connections. In addition to the standard two ports on the PC, either one or two 4-port Communications boards may be added to increase the capacity. See page 9 for installation instructions. If additional lines are required, additional SPR Host units (each with a maximum of 10 serial port connections) can be networked and share the same election files. Each serial port that will be used for handling counter connections must be equipped with a Hayes Optima™ or compatible 9600 baud modem.

Phone lines being used with the counters should be part of a sequential hunt group all accessed by the same phone number. This allows the incoming calls from counter modems to connect to the first non-busy SPR Host line after the access number is dialed.

SPR Host Setup

The Host setup is the same as described in section five except for the following:

Password: The password for an counter setup is always an 8-digit code beginning with 0000 and ending with your 4-digit counter access code. (For example, if your access code is 5657, your password would be 00005657.)

Counter Installation

When setting up the counter at the polling place, it is advisable to use a *splitter* that provides two telephone socket positions. With this *splitter* plugged into the wall jack, plug the telephone cord into one position and the modem cord into the other position. Then the poll worker will not have to worry about switching telephone connections on election night.

Warning: Be sure the telephone is not in use when the counters are transmitting data.

SPR Parallel Remote Setup

To access the Setup program, follow the steps below.

1. At the C:\ SPR prompt, type **SPRSETUP**. The screen below will display.

Smart Pack Reader Setup (c)2001 Election Systems & Software

<ul style="list-style-type: none"> Quit Get Setup Save Setup Default Setup Election Serial Port Devices Display Server Path Host Path Phone Password Memory Packs Site Product 	<p>REMOTE SETUP Configuration File:</p> <p>Election:</p> <p>Display Lines:</p> <p>Server Path:</p> <p>Host Path:</p> <p>Phone Number:</p> <p>Password:</p> <p>Pack Type:</p> <p>Pack Interface:</p> <p>Host Name:</p> <p>Host Unit:</p> <p>District:</p> <p>District Name:</p> <p>Reader Only: WAN:</p>
---	--

2. Scroll down to Get Setup; then press ENTER.

Smart Pack Reader Setup (c)2001 Election Systems & Software

<ul style="list-style-type: none"> Qui Get For Host Configuration Sav For Remote Configuration Def Election Serial Port Devices Display Server Path Host Path Phone Password Memory Packs Site Product 	<p>Configuration File:</p> <p>Election:</p> <p>Display Lines:</p> <p>Server Path:</p> <p>Host Path:</p> <p>Phone Number:</p> <p>Password:</p> <p>Pack Type:</p> <p>Pack Interface:</p> <p>Host Name:</p> <p>Host Unit:</p> <p>District:</p> <p>District Name:</p> <p>Reader Only: WAN:</p>
--	---

3. Scroll to For Remote Configuration, and press ENTER.

4. At Get Config. File, type **SPR.CFG**. Your screen will then look like the one shown below. If you have entered setup parameters previously, those previously saved settings present will display.

```

Smart Pack Reader Setup      (c)2001 Election Systems & Software

Quit
Get Setup
Save Setup
Default Setup
Election
Serial Port Devices
Display
Server Path
Host Path
Phone
Password
Memory Packs
Site
Product

Configuration File: SPR.CFG

Election: TESTELEC

Display Lines: LOW,COLOR
Server Path: C:\SPR
Host Path: C:\SPR
Phone Number: 13077398634
Password: 00005657
Pack Type: M100
Pack Interface: MPR
Host Name:
Host Unit:
District: 0001
District Name: TEST SITE
Reader Only:
WAN:
  
```

5. Scroll down to Memory Packs, and press ENTER. Your screen will look like the one shown on the next below.

```

Smart Pack Reader Setup      (c)2001 Election Systems & Software

Quit
Get Setup
Save Setup
Default Setup
Election
Serial Port Devices
Display
Server Path
Host Path
Phone
Password
Memory Packs
Site
Product

REMOTE SETUP
Configuration File: SPR.CFG

Election: TESTELEC

Memory Pack Setup
Pack Type: M100
Pack Interface: MPR
Read Mode: MANY
Pack Image Save: SAVE

Default Setup
Pack Type
Pack Interface
Pack Read Mode
Pack Image Save

District: 0001
District Name: TEST SITE
Reader Only: YES
WAN:
  
```

6. Scroll down to Pack Type, and press ENTER. Your screen will look like the one shown on the next page.

Smart Pack Reader Setup		(c)2001 Election Systems & Software	
Quit		REMOTE SETUP	Configuration File: SPR.CFG
Get Setup			
Save Setup			
Default Setup			
Election			Election: TESTELEC
Serial Po	Memory	DUMMY	
Display		(OP2) Optech II	
Server Pa		(OP3P) Optech IIIP	
Host Path		Eagle Rom Pack	
Phone	Pack	Eagle Ram Pack ←	Default Setup
Password		PBC 2100	Pack Type ←
Memory Pa	Pack 1	PBC 4	Pack Interface ←
Site		V2000	Pack Read Mode
Product		M100	Pack Image Save
		District: 0001	
		District Name: TEST SITE	
		Reader Only: YES	WAN:

7. Scroll down to Eagle RAM Pack if you are using the Optech III-P Eagle, V2000 if you are using the V-2000, or M100 if you are using the Model 100; then press ENTER.
8. Scroll to Pack Interface, and press ENTER.

Smart Pack Reader Setup		(c)2001 Election Systems & Software	
Quit		REMOTE SETUP	Configuration File: SPR.CFG
Get Setup			
Save Setup			
Default Setup			
Election			Election: TESTELEC
Serial Po	Memory	PC Bus Adapter	
Display		IDA	
Server Pa		PCM Card Slot 0	
Host Path		PCM Card Slot 1	
Phone	Pack	MPR ←	Default Setup
Password		Read Mode: MANY	Pack Type
Memory Pa		Pack Image Save: SAVE	Pack Interface ←
Site			Pack Read Mode
Product			Pack Image Save
		District: 0001	
		District Name: TEST SITE	
		Reader Only:	WAN:

9. Select MPR for reading MemoryPacks, IDA for the IDA device, or the appropriate PCM card slot for the M-2100; then press ENTER.

10. Scroll down to Pack Read Mode, and press ENTER.

```

Smart Pack Reader Setup      (c)2001 Election Systems & Software

Quit
Get Setup
Save Setup
Default Setup
Election
Serial Port Devices
Display
Server Path
Host Path
Phone
Password
Memory Path
Site
Product

REMOTE SETUP
Configuration File: SPR.CFG

Election: TESTELEC

Pack Type: M100
Pack Interface: HPR
Read Mode: MANY
Pack Image Save: SAVE

Default Setup
Pack Type
Pack Interface
Pack Read Mode
Pack Image Save

District: 0001
District Name: TEST SITE
Reader Only: YES

WAN:
    
```

11. Select ONE or MANY, and press ENTER.

12. Scroll to Site, and press ENTER.

```

Smart Pack Reader Setup      (c)2001 Election Systems & Software

Quit
Get Setup
Save Setup
Default Setup
Election
Serial Port Devices
Display
Server Path
Host Path
Phone
Password
Memory Path
Site
Product

REMOTE SETUP
Configuration File: SPR.CFG

Election: TESTELEC

Display Lines: LOW,COLOR

Remote District Number: 0001
Remote District Name: TEST SITE

Host Unit Number:
Host Name:

Remote: District
District Name
Host: Unit Number
Host Name

Reader Only: YES

WAN:
    
```

13. Select the district number and name and the Host number and name.

14. Press ESC to return to the Setup Menu.

15. Select Save Setup, and press ENTER.
16. Select Quit to exit the setup program.
17. Press F3 to confirm that you want to exit the setup program. Press any other key to avoid exiting.

SPR Host Setup

The password for an Eagle, M100 or V-2000 setup is always an 8-digit code beginning with 0000 and ending with your 4-digit Eagle Access Code. (For example, if your access code is 5657, your password is 00005657.)

Setting up Acquisition Manager with a Model 2100

Use the Acquisition Manager to read Memory Cards from the Model 2100 punch-card ballot counter. The pack type and the pack interface must be setup first. You must have SPRSETUP 1.4 or greater.

SPR with Model 2100 Installation

1. Insert the PCMCIA Hayes™ compatible modem card into the bottom slot on the left side of the notebook PC. Insert the PCMCIA slot adapter into the top slot.

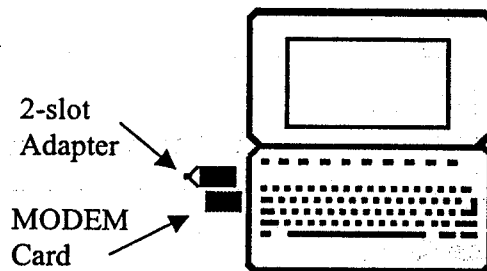

2. Insert the Memory Card into either of the two slots of the adapter.
3. Plug the telephone line cord into the modem card.
4. To determine whether the slot you are using is slot 0 or slot 1, type **PCM_0** at the C:\SPR prompt. If there are **numbers** at the top of the file that displays on your screen, you are using **slot 0**. If there are **zeros only**, you are using **slot 1**. Later in the setup, you will need to know which slot you are using.

SPR with Model 2100 Remote Setup

1. At the C:\SPR prompt, type **SPRSETUP**. The SPR Setup menu screen, similar to the one shown below, will display.

Smart Pack Reader Setup (c)2001 Election Systems & Software

Quit
 Get Setup
 Save Setup
 Default Setup
 Election
 Serial Port Devices
 Display
 Server Path
 Host Path
 Phone
 Password
 Memory Packs
 Site
 Product

REMOTE SETUP
 Configuration File:

Election:
 Display Lines:
 Server Path:
 Host Path:
 Phone Number:
 Password:
 Pack Type:
 Pack Interface:
 Host Name:
 Host Unit:
 District:
 District Name:
 Reader Only: WAN:

2. Scroll to Get Setup, and press ENTER.

Smart Pack Reader Setup (c)2001 Election Systems & Software

Quit
Get For Host Configuration
Save For Remote Configuration
 Def
 Election
 Serial Port Devices
 Display
 Server Path
 Host Path
 Phone
 Password
 Memory Packs
 Site
 Product

REMOTE SETUP
 Configuration File:

Election:
 Display Lines:
 Server Path:
 Host Path:
 Phone Number:
 Password:
 Pack Type:
 Pack Interface:
 Host Name:
 Host Unit:
 District:
 District Name:
 Reader Only: WAN:

3. Scroll to For Remote Configuration, and press ENTER.

Smart Pack Reader Setup (c)2001 Election Systems & Software

Quit	REMOTE SETUP
Get Setup	Get config file: SPR.CFG file:
Save Setup	
Default Setup	
Election	Election:
Serial Port Devices	Display Lines:
Display	Server Path:
Server Path	Host Path:
Host Path	Phone Number:
Phone	Password:
Password	Pack Type:
Memory Packs	Pack Interface:
Site	Host Name:
Product	Host Unit:
	District:
	District Name:
	Reader Only: WAN:

4. At Get Config. File:, type **SPR.CFG**. Your screen will then look similar to the one shown below, with the last saved settings present.

Smart Pack Reader Setup (c)2001 Election Systems & Software

Quit	Configuration File: SPR.CFG
Get Setup	Election: TESTELEC
Save Setup	Display Lines: LOW,COLOR
Default Setup	Server Path: C:\SPR
Election	Host Path: C:\SPR
Serial Port Devices	Phone Number: 13077398634
Display	Password: 00005657
Server Path	Pack Type: M100
Host Path	Pack Interface: MPR
Phone	Host Name:
Password	Host Unit:
Memory Packs	District: 0001
Site	District Name: TEST SITE
Product	Reader Only: WAN:

5. Scroll down to Memory Packs and press ENTER. Your screen will look similar to the one shown on the next page.

Smart Pack Reader Setup		(c)2001 Election Systems & Software	
Quit	Memory Pack Setup	REMOTE SETUP	
Get Setup		Configuration File: SPR.CFG	
Save Setup		Election: TESTELEC	
Default Setup		Default Setup	
Election		Pack Type: M100	
Serial Po		Pack Interface: MPR	
Display		Read Mode: MANY	
Server Pa		Pack Image Save: SAUE	
Host Path		Pack Type	
Phone		Pack Interface	
Password		Pack Read Mode	
Memory Pa		Pack Image Save	
Site		District: 0001	
Product	District Name: TEST SITE		
	Reader Only: WAN:		

6. Scroll down to Pack Type, and press ENTER. Your screen will look like the one shown below.

Smart Pack Reader Setup		(c)2001 Election Systems & Software	
Quit	Memory Pack Setup	REMOTE SETUP	
Get Setup		Configuration File: SPR.CFG	
Save Setup		Election: TESTELEC	
Default Setup		Default Setup	
Election		Pack Type	
Serial Po		Pack Interface	
Display		Pack Read Mode	
Server Pa		Pack Image Save	
Host Path		DUMMY	
Phone		(OP2) Optech II	
Password		(OP3P) Optech IIIP	
Memory Pa		Eagle Row Pack	
Site		Eagle Ram Pack	
Product	PBC 2100		
	PBC 4		
	U2000		
	M100		
	District: 0001		
	District Name: TEST SITE		
	Reader Only: WAN:		

7. Select PBC 2100, and press ENTER.
8. Scroll to Pack Interface, and press ENTER.

9. Select the card slot you are using (0 or 1). Refer to the slot number you determined in Step 4 on page 72.

```

Smart Pack Reader Setup      (c)2001 Election Systems & Software

Quit
Get Setup
Save Setup
Default Setup
Election
Serial Po
Display
Server Pa
Host Path
Phone
Password
Memory Pa
Site
Product

REMOTE SETUP
Configuration File: SPR.CFG

Election: TESTELEC

PC Bus Adapter
IDA
PCM Card Slot 0
PCM Card Slot 1
MPR

Read Mode: MANY
Pack Image Save: SAVE

Default Setup
Pack Type
Pack Interface
Pack Read Mode
Pack Image Save

District: 0001
District Name: TEST SITE
Reader Only:
WAN:
  
```

The final setup screen will look similar to the one shown below.

```

Smart Pack Reader Setup      (c)2001 Election Systems & Software

Quit
Get Setup
Save Setup
Default Setup
Election
Serial Port Devices
Display
Server Path
Host Path
Phone
Password
Memory Packs
Site
Product

REMOTE SETUP
Configuration File: SPR.CFG

Election: TESTELEC

Display Lines: LOW,COLOR
Server Path: C:\SPR
Host Path: C:\SPR
Phone Number: 13077398634
Password: 00005657
Pack Type: PBC2100
Pack Interface: PCMSLOT1
Host Name:
Host Unit:
District: 0001
District Name: TEST SITE
Reader Only:
WAN:
  
```

10. Press ESC to return to the Setup menu.
11. When everything on the screen is setup correctly, scroll to Save Setup.
12. Scroll to Quit to exit the setup program.
13. Press F3 to confirm that you want to exit the setup program. Press any other key to avoid exiting.

SPR Host Setup

The Host setup is the same as described in section 5 except that the password for the Model 2100 setup is always an 8-digit code beginning with 0000 and ending with your 4-digit 2100 Access Code. (For example, if your access code is 5657, your password is 00005657.)

Chapter 7: IDA Board

The Intelligent Device Adapter (IDA) is a low cost, compact, lightweight, portable device that connects to a serial port on either a laptop or desktop PC and allows for importing the election data contained within the counter, ES&S M100, or the Model 2100 PCM cards. A fixture is mounted on each IDA board to accommodate insertion of any of the above mentioned data packs. The IDA unit plugs into the PC serial port. Power is obtained by using a 9-conductor RS-232 cable that plugs into the PS/2 compatible mouse port. The cable is a pass-through cable enabling the mouse to be connected at the same time, if desired. The design of the interface allows interfacing to any PC, whether it has an internal AT slot or not.

Size and Weight

The IDA unit consists of a stainless steel or aluminum case 7.25" x 4.875" x 2" in size. Cables to connect the IDA to the serial port of the PC and a power cable are included. A sealed carrying case that will house a typical laptop computer and the IDA unit is available as an option. ES&S recommends specific laptop computers for use with the IDA to ensure compatibility.

Principles of Operation

IDA design consists of a single chip microprocessor capable of direct interface to any of the supported election MemoryPacks. An integrated RS-232 (serial) port is programmed to communicate to the attached PC via a proprietary protocol. The PC will be running the SPR software that will allow uploading the election results from the MemoryPack to the remote accumulation network either through a dial-up telephone line or directly connected via the PC's serial port.

Interface with SPR

Once the results have been read into the PC, they are transferred by modem to the central site in the same manner that SPR results are transferred. The IDA runs at 115,200 baud.

Installing the IDA Board

1. To use the IDA board with the SPR, configure a second serial port device in the SPR configuration file (**SPR.CFG**). That port must be set to 115,200. Refer to the sample file below.
2. Select IDA as the pack interface parameter.

The sample SPR.CFG file below suggests how to define the second serial port device. The SPR configuration file must have two serial devices defined as follows:

```
[DEVICE]=first defined device on COM1
baseaddress=3f8
interrupt=4
portsondevice=1
port=9600 ,8,n,1,HANDSHAKE,MODEM

[DEVICE]=second defined device on COM2
baseaddress=2f8
interrupt=3
portsondevice=1
port=115200,8,n,1,HANDSHAKE,MODEM

[PACK]
packtype=EAGLE
packreadmode=MANY
packimage=SAVE
packinterface=IDA
```

Note: The IDA board must be the second device that is defined.

IDA Operation

1. Connect the PS2 cable before starting the SPR software. A green light on the IDA board indicates the power is ON. The red status light on the IDA board will blink about every four seconds indicating the IDA board is functioning.
2. When the power light is ON and the status light is blinking, insert the MemoryPack or the PCMCIA card into the IDA.
3. Press ENTER to read in the pack results.
4. Remove the pack and insert the next one. The results are then sent by modem to the central site.
5. Repeat steps 2 through 4 until all packs have been read.

Hardware Installation Procedures

SPR Host Unit

The SPR Host utilizes external modems connected to the SPR remote sending unit's internal modem.

4-Port Communications Board and Modem Installation

1. Install a 4-port communications board in any empty slot in the SPR Host computer unit.

The default IRQ setting is 5. The default Port Base Address is **280 HEX**. The default dip switches are shown on page 10.

2. Using the 4-port cable assembly supplied with the 4-port communication board, connect the 50-pin connector on the cable to the rear of the 4-port board.
3. Connect one 25-pin cable connector to each port connector at the rear of each external Hayes 9600 compatible modem for each remote SPR unit. If the SPR sending unit will be direct-connected to the SPR Host, use the supplied direct-connect cable to connect between any one of the four 25-pin connectors and the serial (RS-232) connectors on the SPR sending unit (COM1 or COM2). An ES&S FULL HANDSHAKE NULL MODEM adapter must be used on the SPR Host RS-232 cable if it is to be directly connected to an SPR sending unit.

Remote Regional Site Sending Units

1. To open the sending unit carrying case, press on each corner above the latches while simultaneously pulling forward on the plastic cover latch.
2. Carefully remove the laptop computer from the foam, and lay it flat on a clean, smooth surface. Do not turn ON the laptop until instructed to do so later.
3. Pull the IDA unit from the foam cavity and set it 6" – 8" to the right side of the laptop computer.
4. Remove the IDA serial cable (9-pin to 9-pin cable). Note that one end of the cable has pins in the connector (for the IDA connection), and the other end contains holes that fit into the laptop connector. Connect the end with the holes to the rear communication port of the laptop. Then connect the end with the pins to the corresponding 9-pin connector on the IDA box.
5. Remove the coiled power cable from the carrying case and carefully align it in the round mouse connector at the left rear of the laptop and firmly press it in until it is flush with the laptop case.
6. Depress the plastic tabs at the square connector end of the power cable and insert it into the square hole in the IDA box marked POWER. Press on the connector until both tabs snap securely into the hole.
7. Remove the laptop computer power module from the carrying case along with the special A/C power cord that connects from the wall outlet to the power module.
8. Plug the small power pin into the laptop power hole that is located at the right rear of the laptop (when facing the front of the laptop). Be sure to push the pin into the hole until it is fully seated.
9. Plug the 3-hole end of the laptop computer power cord securely into the power module. Plug the other end of the power cord into a 120 volt grounded A/C power outlet. Ideally, the power outlet should be a surge-protected outlet to avoid potential power glitches. **DO NOT** run the laptop from the internal laptop battery.

10. Open the laptop cover by sliding the lid latch, located at the front of the lid, to the right while raising the lid. Push the lid perpendicular (straight up) to the laptop keyboard.
11. Start the laptop computer by sliding the raised switch, located at the left center near the back of the keyboard, to the right for about 1 second and then release it to the left. Power up may take as long as two minutes. When the laptop is ready for use, the Smart Pack Reader remote program disclaimer screen will be displayed on the LCD screen.
12. Press the ENTER key. The election name will display.

Warning: Do not press the TAB key until instructed to do so.

The remaining instructions depend on the Modem Control window being highlighted. If it is not the highlighted window, use the TAB key to switch to the proper window.

Observe the hotkeys shown at the bottom of the screens in order to know when a given key is active.

13. Press the F3 key once to select the election name. The laptop internal modem will initialize.
14. Check to be sure that the message below displays in green text at the bottom of the screen.

MODEM OK

If the above message does not display within a few seconds, call central support for assistance.

15. Press F5 to call to the Central Communication host computer.

While the dialing sequence is occurring, the telephone number being dialed will display on the bottom left of the screen. Be sure that the correct number is displayed. If it is not correct, call central support.

16. Press TAB to highlight *Press ENTER Key to Read Pack*.
17. Insert the data pack or memory card into the IDA unit.
18. Press ENTER to transmit the pack to the central accumulation center.
19. Remove the pack/card from the IDA fixture.
20. Repeat steps 17 through 19 until all data packs or PBC-2100 cards are sent.
21. Shut down the send unit laptop computer by pressing the F3 key twice in quick succession. Exit the Windows environment by pressing the Windows key; then press the U key followed ENTER.
22. After the computer shuts OFF, disconnect the IDA box cables, unplug the laptop computer, and repackage it into the send unit carrying case.

Chapter 8: Files Definition

Files Needed To Run the Host

There are numerous files in conjunction with the SPR system. On the following pages are definitions of these files in terms of how they are generated and what they are used for.

HOST.EXE	SPR Host program
HOST.CFG	Configuration file for the host
electionname.SPL	List of precincts generated by Election Reporting Manager and Hardware Reporting Manager and stored in the ELECDATA sub-directory
*electionname.SPS	Precinct pack status list. Initialized from electionname.SPL at the start of the election.
*electionname.SPH	Host log
*electionname.SPP	Queue for Election Reporting Manager format packs. Must exist before Election Reporting Manager starts.
*SPRPHONE.DAT	Phone numbers
*SPRELEC.DAT	Election names

* Created by SPR Host if it does not exist

Additional programs:

LV.EXE	Real-time log viewer. Refer to Appendix A.
AQ.EXE	Simulates Election Reporting Manager read of electionname.SPP queue file. Refer to Appendix A.

Files Needed To Run the Remote

Only SPR.EXE, SPR.CFG, SPRELEC.DAT AND SPRPHONE.DAT should exist when a new election starts.

- *electionname.SPS Status of each precinct's pack. Initial contents are created when host downloads precinct list.
- *electionname.SPP Queue for packs read in to be sent
- *electionname.SPI Multiple pack image accumulation
- *electionname.SPR SPR Remote unit's log
- *SPRPHONE.DAT Phone numbers
- *SPRELEC.DAT Election names

* Created by SPR Remote if it does not exist

Note: Remote Pack Images are saved only when the packimage=save option is selected for the SPR.cfg file and the pack has an error during read operation or the pack is put in queue to be sent.

Prior to the start of an election, the following files should be deleted or removed from the SPR's directory if they exist:

electionname.SPS electionname.SPI
electionname.SPP electionname.SPR

To delete these files, type **RESET** *electionname* at C:\SPR.

Chapter 9: Error Messages

ABORT—WHILE WAITING FOR DATA

Remote sending unit is not responding to request for data from the Host computer.

APPEND OF AERO FORMAT RECORD FAILED

The disk is probably full or the LAN connection has been broken.

BAD XMODEM CRC, ATTEMPTING RE-SEND RECORD

Electrical noise is interfering with the transfer of data over the communication line.

REMEDY: Hang up and re-establish your connection.

BAD XMODEM CRC, RE-TRIES EXCEEDED

After several failed attempts to send data, the transfer has been canceled.

CRC RECEIVED XMODEM RECORD

Record with errors was received. A re-send of the data will be attempted.

CANNOT ACCESS FILE

The sub-directory name in the .CFG file has not been created.

CANNOT ALLOCATE MEMORY FOR PRECINCT INDEX.

Insufficient memory.

CANNOT ALLOCATE RECEIVE CONTROL BLOCK

Insufficient memory.

CANNOT SAVE RECEIVED PACK.

Disk is probably full or LAN connection is broken.

CANNOT SEND PACK, BLOCK TRANSFER FAILED

Communications line not working.

DATA ABORT WAITING FOR PRECINCT LIST

Host

DATA FAIL WAITING FOR PRECINCT LIST

Host

DATA TIMEOUT WAITING FOR PRECINCT LIST

Host

FAIL—WHILE WAITING FOR DATA.

Remote is not responding

FILE LOCKING CONTENTION

Another program has the file locked or DOS SHARE.EXE has not been loaded.

HOSTPATH DIRECTORY IN CONFIG FILE NOT FOUND

Directory does not exist or LAN connection is broken.

INSUFFICIENT MEMORY FOR PRECINCT LIST BLOCK SEND

Too many precincts in district.

MEMORY ALLOCATION FAILED

Insufficient memory.

MODEM ABORTED

Remote

MODEM DOES NOT RESPOND TO COMMANDS

Modem might not be connected or turned on.

MODEM TIMED OUT

Modem might not be turned on.

NO MEMORY TO SEND PRECINCT LIST

Insufficient memory.

PACK IS NOT VALID.

CRC or Parity on pack detected corrupt data.

REMEDY: Be sure the pack is inserted properly and try again.

RE-TRY TO READ PACK

A previous attempt to read the pack failed.

RETRIES FAILED ON BLOCK TRANSFER

Electrical noise may exist on the communications line, or the Host is not responding.

RETRY FAILURE

Attempt to re-send last data failed. Noise on communications line or baud rate incorrect

SERVERPATH DIRECTORY IN CONFIG FILE NOT FOUND

Directory does not exist or LAN connection is broken.

TIMEOUT - WHILE WAITING FOR DATA

The communications line may have too much noise or may be broken.

TOO MANY DEVICES IN CONFIG FILE

Too many precincts.

UNABLE TO ACCESS PRECINCT STATUS FILE

Directory does not exist or LAN connection is broken.

UNABLE TO ALLOCATE MEMORY FOR PACK IMAGE READ

Insufficient memory.

UNABLE TO ALLOCATE MEMORY FOR PRECINCT LIST

Insufficient memory.

UNABLE TO ALLOCATE RECEIVE BUFFER

Insufficient memory.

UNABLE TO LOCK AERO PACK FILE

Another program has the file locked or DOS SHARE.EXE has not been loaded.

UNABLE TO OPEN CONFIGURATION FILE

The configuration file does not exist in the directory that SPR.EXE is in.

UNABLE TO OPEN PACK IMAGE FILE

The disk is full or the LAN connection is broken.

UNABLE TO OPEN PRECINCT STATUS FILE

The LAN connection is broken or the file does not exist.

UNABLE TO OPEN PRECINCTS FILE

The LAN connection is broken or the precinct list was not created.

UNABLE TO READ FROM DISK

The file is corrupt or the LAN connection is broken.

UNABLE TO READ PACK

The pack type in the config file might be incorrect.

UNABLE TO UNLOCK AERO PACK FILE

Another program has the file locked or DOS SHARE.EXE has not been loaded.

UNABLE TO WRITE LOG TO DISK

The disk is full or the LAN connection is broken.

UNABLE TO WRITE PACK TO DISK

The LAN connection is broken or the disk is full.

THE UNITED STATES OF AMERICA
DEPARTMENT OF THE ARMY
OFFICE OF THE ADJUTANT GENERAL
WASHINGTON, D. C.

ADJUTANT GENERAL
OFFICE OF THE ADJUTANT GENERAL
WASHINGTON, D. C.

ADJUTANT GENERAL
OFFICE OF THE ADJUTANT GENERAL
WASHINGTON, D. C.

ADJUTANT GENERAL
OFFICE OF THE ADJUTANT GENERAL
WASHINGTON, D. C.

ADJUTANT GENERAL
OFFICE OF THE ADJUTANT GENERAL
WASHINGTON, D. C.

ADJUTANT GENERAL
OFFICE OF THE ADJUTANT GENERAL
WASHINGTON, D. C.

ADJUTANT GENERAL
OFFICE OF THE ADJUTANT GENERAL
WASHINGTON, D. C.

ADJUTANT GENERAL
OFFICE OF THE ADJUTANT GENERAL
WASHINGTON, D. C.

ADJUTANT GENERAL
OFFICE OF THE ADJUTANT GENERAL
WASHINGTON, D. C.

Appendix A: Sample Configurations

Sample Configuration for Host

```

SPR CONFIG FILE    =* filename must be SPR.CFG for Remote unit
                  =* filename must be HOST.CFG for Host unit

                  [DEVICE SPECS]

DEVICE SPECS      =* create an entry for each item in the config file
=
                  ELECTION |
                  1{DEVICE}8 |
                  SITE |
                  DISPLAY |
                  PHONE |
                  ACCESS |
                  PACK |
                  SERVER |
                  HOST |
                  SEMI COLON

ELECTION          *ENTER THE ELECTION SPECIFIC FILE NAMES
=
                  =
                  "[ELECTION]+CRLF +
FILENAME          =* "ELECTIONFILES=" + FILENAME
=
                  1{CHAR}8

DEVICE            =* Up to eight physical devices may be installed.
                  =* However the maximum number of serial ports cannot
                  =* exceed ??? <— this could change up to 32 depending
                  =* on the ability of the CPU to process the interrupts.
                  =* And the memory limitations under DOS.
                  =*
                  =*
                  =* NOTE: ES&S limit on serial ports per host is proposed
                  =* to be four.
                  =*
                  =* One device could have eight serial ports or there
                  =* could be two four port boards, or there could be
                  =* one four-port board and two COM ports enabled.
                  =
                  "[device]" + CRLF +
                  "baseaddress=" +
PORT +
                  "interrupt=" +
PC IRQ +
                  "portsondevice=" +
{"port=" +
                  "boards=" +
1|2|3 4 +
PORT PARAMETERS}8

@CFG-FILE = DEFAULT MULTI-PORT =* Off the shelf base address for

```

PORT =* NOTE: Only one PC com port per IRQ since PC cannot share
 =* com port IRQ's
 = [COM1 | COM3] | [COM2 | COM4] |

DEFAULT MULTI-PORT
 =* Off the shelf base address for COMM4AT board.
 0x280

COM1 = 0x3f8
 COM2 = 0x2f8
 COM3 = 0x3e8
 COM4 = 0x2e8
 PC IRQ = 3 | 4 | 5 | 7 | 10 | 11 | 12 | 15
 PORTS = 1 | 2 | 3 | 4 | 5 | 6 | 7 | 8

PORT PARAMETERS =
 =
 BAUD RATE + COMMA +
 CHAR SIZE + COMMA +
 PARITY + COMMA +
 STOP BITS + COMMA +
 "handshake" + COMMA +
 MODE

BAUD RATE =* NOTE: Only baud rate of 2400 or less will be accepted
 =* if the serial port is not an 16550 UART.

=
 1200 |
 2400 |
 4800 |
 9600 |
 19200 |
 38400 |
 57600 |
 115200 |

CHAR SIZE =* eight bit characters
 =
 8

PARITY =* no parity is used
 =
 N

STOP BITS =* always use two stop bits for best reliability
 =
 2

MODE	=* mode of connection to SPR Remote unit = "modem" "local"
SITE	=* for the host, "hostunit" a number from 0 to 9 used to =* identify multiple host PC's running in the same election =* =* =* ="[site]" + CRLF ("district=" + DISTRICT + CRLF "districtname=" + DISTRICTNAME) ("hostname=" + HOSTNAME + CRLF) "hostunit=" + HOSTIDNUMBER } + CRLF
DISTRICT	=* This is used to get a list of all precincts that are expected =* to be sent from this location. = = 4{CHAR}4
DISTRICTNAME	=* name to identify location or operator at remote site. Could =* be the township, a person's name, etc. =* = 0{CHAR}15
HOSTNAME	=* name to identify host system which receives packs. =* i.e., "Cook County" = 0{CHAR}15 "hostunit=" + HOSTIDNUMBER } + CRLF
DISPLAY	=* controls how many lines and whether to use color = = "[display]" + CRLF + = "lines=" + "high" "low" + = [" ,color"]
PHONE	=* phone setup and default phone number when dialing = "[phone]" + CRLF + "dialingmode=" + DIALMODE + CRLF + "hostphone=" + PHONENUMBER + CRLF + ["modemsetup=" + MODEMSETUPSTRING + CRLF + " "modemdialcommand=" + MODEMDIALSTRING + CRLF]
DIALMODE	=* mode used when dialing "tone" "pulse" "leased" "ud"
MODEMSETUPSTRING	=*
MODEMDIALSTRING	=*
PHONENUMBER	=* standard telephone number =* May include commas to provide delays in dialing through =* switchboards.
ACCESS	=* system wide password ALL remotes will use to call in and =* gain access to the host. = "[access]" + CRLF + "password=" + PASSWORD
PASSWORD	= = 8{CHAR}8

PACK =* Type of packs to read.
 =*
 =* The packreadmode controls how many packs can be queued
 =* on the disk at a time. With "one", only one pack can be
 =* written to the queue to await sending.
 =*
 =* If packimage=save the image of the pack will be saved
 =* in addition to an AERO format being put in the transmit
 =* queue.
 =* The pack will be saved as a 64kb image, but if "compress"
 =* is used the image will be compressed down to about 3kb.
 =* Of course, a hex dump requires de-compression for the
 =* compressed images.
 =
 "[pack]" + CRLF +
 "packtype=" + PACKCODE + CRLF +
 "packreadmode=" + "one" | "many" + CRLF +
 "packimage=" + "save"+
 [",compress"]

PACKCODE = "dummy" |
 "op3p" |
 "eagle" |
 "pbc4"

SERVER =* This is the sub-directory where the SPR Host and Remote
 =* will put
 =* received packs for Aero(AEROPACK.SPR). =
 "[server]" + CRLF +
 "serverpath=" +
 DSPATH

HOST =* This is the sub-directory where the SPR Host will put
 =* its log file and its pack status file (<<election>>.SPS).
 =
 "[host]" +CRLF +
 "hostpath=" +

DSPATHDSPATH
 =* any valid path in DOS

Sample Configuration for Remote Unit

```
***** Sample configuration for Smart Pack Reader Remote unit *****
.....
;file: spr.cfg
Sample configuration for Smart Pack Reader Remote unit

t [election]
electionfiles=3gmnmoor
; com1 on PC
.
[device]
baseaddress=3f8
interrupt=4
portsondevice=1
port=9600,8,N,2,handshake,modem
.
; name of township or location where this reader will be
.
;ID this reader will send to host to login, 9999TO NOT GET PRECINCT LIST
[site]
district=0001
districtname=EVANSTON
.
.
[display]
lines=low,color
;lines=low

[phone]
dialingmode=TONE
hostphone=5551212
.
.
[access]password=12345678
.
.
[pack]
packtype=op3p
packreadmode=many
packimage=save
;packimage=save, compress
;packtype=dummy
.
.
;sub-dir where Aero packs will be stored
.
[server]
serverpath=c:\spr
;serverpath=i:\spr
.
.
.
```

;sub-dir where log and precinct status file are

[host]

hostpath=c:\spr

;hostpath=i:\sp

r

:

:

:

[remote]

remotepath=c:\sp

r;remotepath=i:\spr

:

;the end.

Sample Configuration for Host with Four Serial Ports

```
.....
..... Sample configuration for Smart Pack Reader Host unit .....
..... with four serial ports .....
.....
;file: host.cfg

; setup one multi-port board which has four channels of 16550 UARTS
; Three will be connected to modems and one will be a direct local hookup
;
;
[election]
electionfiles=3gmnmoor
;
;
[device]
baseaddress=300
interrupt=5
portsondevice=4
port=9600,8,N,2,handshake,modem
port=9600,8,N,2,handshake,modem
port=9600,8,N,2,handshake,modem
port=115200,8,N,2,handshake,local
;
;
[display]
lines=high,color
;lines=high
;
; where AERO will expect to find data
[server]
serverpath=c:\spr
;serverpath=i:\spr
;
; where host will put received packs and log file
[host]
hostpath=c:\spr
;
;
[site]
hostname ES&S Rockford,Il.
hostunit=1
;
;
[phone]
dialingmode=TONE
hostphone=5551212
;
;
[pack]
packtype=dummy
;packtype=op3p
```

Sample Configuration for Host With Six Serial Ports

```

***** **Sample configuration for Smart Pack Reader Host unit*****
*****with six serial ports*****
*****
;file: host.cfg
;
; setup one multi-port board which has four channels of 16550 UARTS
; Three will be connected to modems and one will be a direct local hookup
;
[election]
electionfiles=3gmnmoor
;
[device]
baseaddress=300
interrupt=5
portsondevice=4
port=9600,8,N,2,handshake,modem
port=9600,8,N,2,handshake,modem
port=2400,8,N,2,handshake,modem
port=115200,8,N,2,handshake,local
;
[device]
baseaddress=3f8
interrupt=4
portsondevice=1
port=2400,8,N,2,handshake,modem
;
; com2 on PC
;
[device]
baseaddress=2f8
interrupt=3
portsondevice=1
port=2400,8,N,2,handshake,modem
;
[display]
lines=high,color
;lines=high
;
; where AERO will expect to find data
;
[server]
serverpath=c:\spr
;
serverpath=i:\spr
;
; where host will put received packs and log file
;
[host]
hostpath=c:\spr
;
[site]
hostname=ES&S Rockford
hostunit=1
;
[phone]
dialingmode=TONE
hostphone=5551212
;
[pack]
packtype=dummy
;packtype=op3p

```

Appendix B: Cable/Connector Wiring Diagrams

Loop Back Test Connector

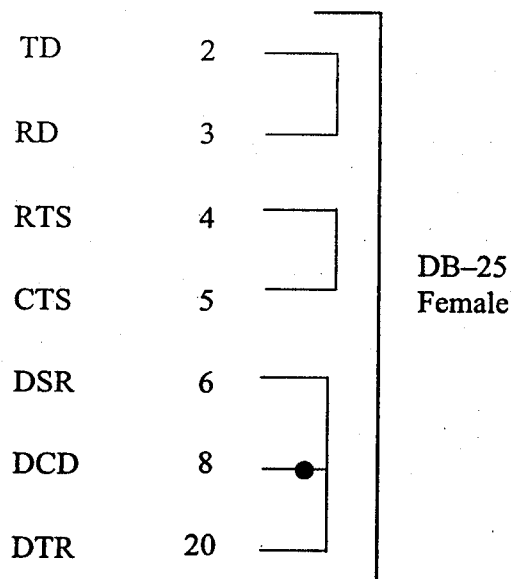

THE UNIVERSITY OF CHICAGO
DIVISION OF THE PHYSICAL SCIENCES
DEPARTMENT OF CHEMISTRY

RESEARCH REPORT

NO. 1000
1955

A

SPR Direct Connect Handshake Null-Modem Adapter

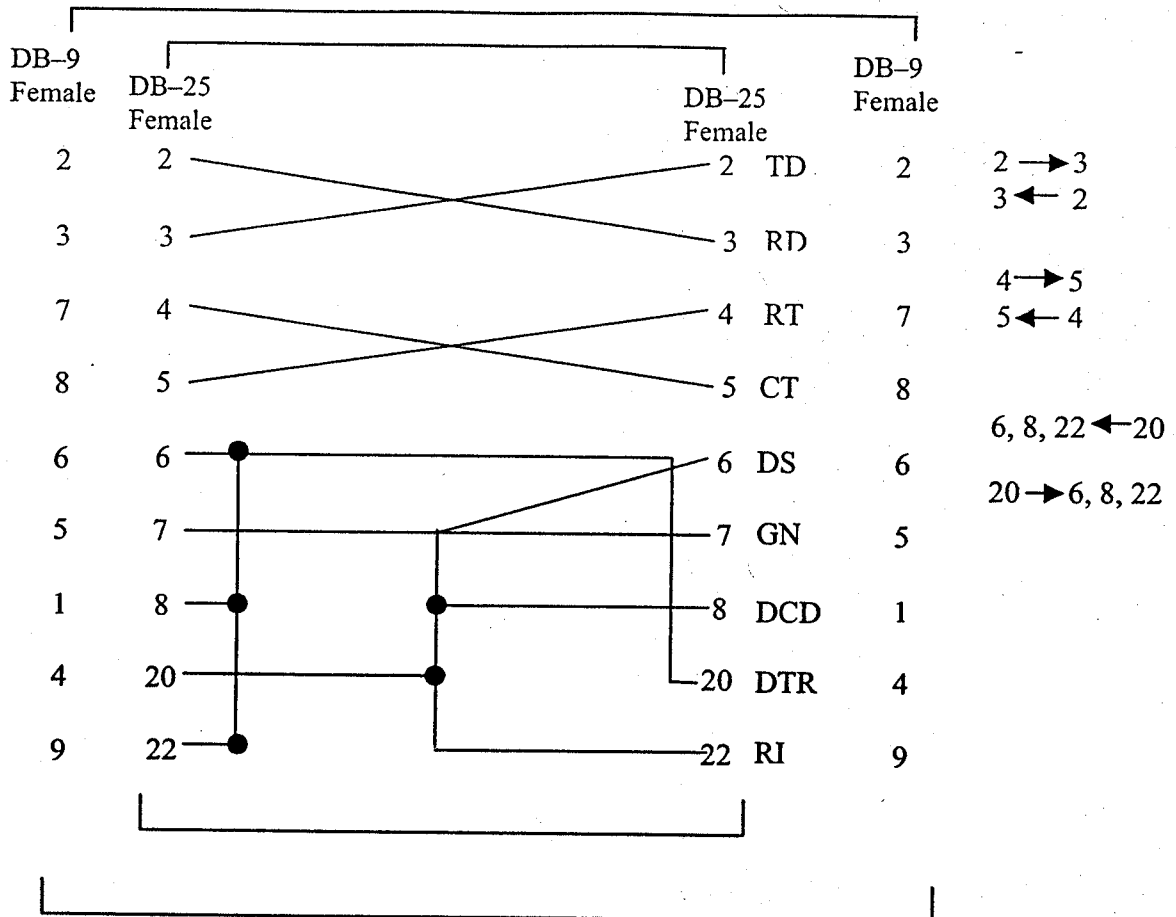

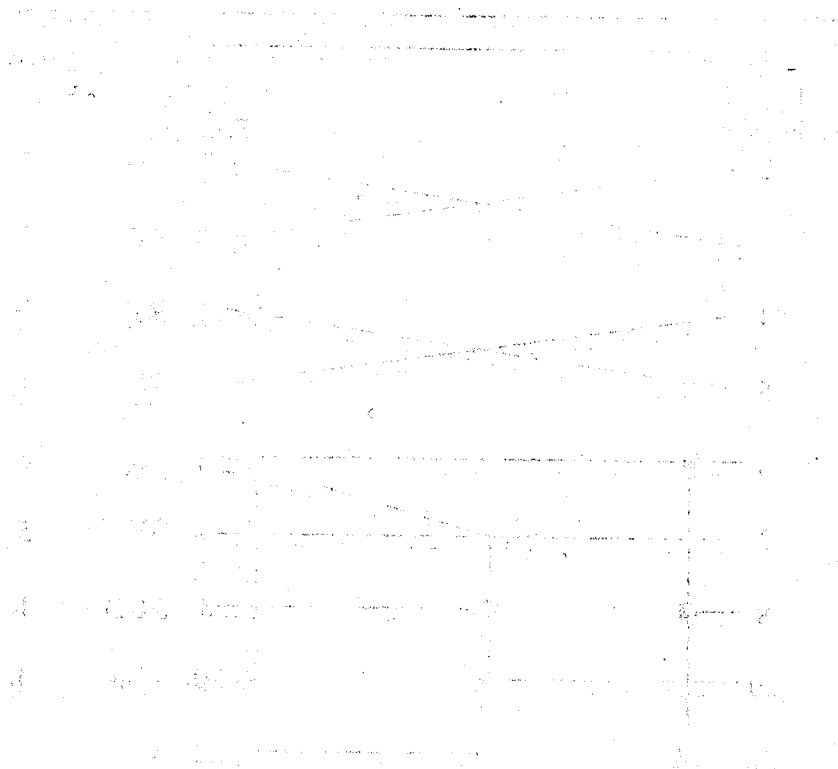

Appendix C: Acquisition Manager Utilities

Log Program

The log viewer program LV.EXE displays the log in real time. In addition, the operator can scroll through the log to view previous activity. The log viewer can be used two ways. It can be run after the SPR Host has received all the packs for the election and has been shut down, or the log viewer can run on a second PC to display and view activity of the SPR Host as it occurs. In addition, when more than one SPR Host is running in the election, all the SPR Hosts write to the same log file. Subsequently, all the activity for the election can be seen on one display.

To run the program, type **LV <path><electionname>.SPH** at C:\SPR.

Messages written to log files are usually prefixed by a two character code to facilitate finding specific type of log entries:

SPR Host and Remote Log Entry Codes

CODE	TYPE OF LOG ENTRY
ER	Error
CF	From the Config File
SI	System Initialization
MD	Modem related
RD	Pack Read
PK	Pack Disposition
WR	Pack Written
AT	Attempt to Send Pack
SE	Pack Sent
H <i>n</i>	Host # (when <i>n</i> is the Hostunit number)
RV	Pack Receiver
MG (MSG or SRP)	Message Sent

Sample Logs

Host Log

06/14/1994	11:54:40	H1- - - - -
06/14/1994	11:54:40	H1 Smart Pack Reader (Host) v1.97 (c)1994 ES&S ROCKFORD
06/14/1994	11:54:40	H1 ESS ROCKFORD Host Session:
06/14/1994	11:54:40	H1 After receive buffers set, memory left 3596000
6/14/1994	11:54:40	H1 After indexes, memory left 292272
06/14/1994	11:54:40	H1 CF [election]
06/14/1994	11:54:40	H1 CF electionfiles=mn-spec
06/14/1994	11:54:40	H1 CF [device]
06/14/1994	11:54:40	H1 CF baseaddress=300
06/14/1994	11:54:40	H1 CF interrupt=7
06/14/1994	11:54:40	H1 CF portsondevice=4
06/14/1994	11:54:40	H1 CF port=9600,8,N,2,handshake,modem
06/14/1994	11:54:40	H1 CF port=9600,8,N,2,handshake,modem
06/14/1994	11:54:40	H1 CF port=9600,8,N,2,handshake,modem
06/14/1994	11:54:40	H1 CF port=9600,8,N,2,handshake,modem
06/14/1994	11:54:40	H1 CF [display]
06/14/1994	11:54:40	H1 CF lines=high,color
06/14/1994	11:54:40	H1 CF [server]
06/14/1994	11:54:40	H1 CF serverpath=c:\c
06/14/1994	11:54:40	H1 CF [host]
06/14/1994	11:54:40	H1 CF hostpath=c:\c
06/14/1994	11:54:40	H1 CF [site]
06/14/1994	11:54:40	H1 CF hostname=ESS Rockford, Il.
06/14/1994	11:54:40	H1 CF hostunit=1
06/14/1994	11:54:40	H1 CF [phone]
06/14/1994	11:54:40	H1 CF dialingmode=tone
06/14/1994	11:54:40	H1 CF hostphone=2
06/14/1994	11:54:40	H1 CF [pack]
06/14/1994	11:54:40	H1 CF packtype=eagle
06/14/1994	11:54:40	H1 SI Password 12345678
06/14/1994	11:54:40	H1 SI District 0000
06/14/1994	11:54:40	H1 SI Host PathC:\C\
06/14/1994	11:54:40	H1 SI ServerPathC:\C\
06/14/1994	11:54:40	H1 SI Pack Type
06/14/1994	11:54:40	H1 SI Modem Setup EOV1&D3&C1S0=2&W
06/14/1994	11:54:40	H1 SI Status File C:\C\MN-SPEC.SPS
06/14/1994	11:54:40	H1 SI Aero Pack File C:\C\MN-SPEC
06/14/1994	11:54:40	H1 MD CHANNEL= 1
06/14/1994	11:54:40	H1 MD CH=1 Modem Init:EOV1&D3&C1S0=2&W
06/14/1994	11:54:44	H1 MD Modem initialized.
06/14/1994	11:54:44	H1 MD CHANNEL= 2
06/14/1994	11:54:44	H1 MD CH=2 Modem Init:EOV1&D3&C1S0=2&W
06/14/1994	11:54:48	H1 MD Modem initialized.
06/14/1994	11:54:48	H1 MD CHANNEL= 3
06/14/1994	11:54:49	H1 MD CH=3 Modem Init:EOV1&D3&C1S0=2&W
06/14/1994	11:54:52	H1 MD Modem initialized.
06/14/1994	11:54:53	H1 MDCHANNEL= 4
06/14/1994	11:54:53	H1 MD Modem not connected or power to modem is not on.
06/14/1994	11:54:53	H1 MDCH=4 Modem Init:EOV1&D3&C1S0=2&W

06/14/1994	11:54:57	H1 MD	Modem will not initialize properly.			
06/14/1994	11:54:57	H1 MD	Serial port set for local connection.			continued
06/14/1994	11:55:11	H1	SPR Connect	Ch=4	Di:0004	
06/14/1994	11:55:11	H1	Logged in.			
06/14/1994	11:55:11	H1	SPR Connect	Ch=4	Di:0004	Site:ELK GROVE
06/14/1994	11:55:11	H1	memory left 279504			
06/14/1994	11:55:15	H1	Precinct list sent.			CH= 4
06/14/1994	11:56:14	H1	SPR Connect	Ch=2	Di:0001	
06/14/1994	11:56:14	H1	Logged in.0			
6/14/1994	11:56:14	H1	SPR Connect	Ch=2	Di:0001	Site:NORTHBROOK
06/14/1994	11:56:14	H1	memory left 275664			
06/14/1994	11:56:19	H1	SPR Connect	Ch=3	Di:0003	
06/14/1994	11:56:19	H1	Logged in.			
06/14/1994	11:56:19	H1	SPR Connect	Ch=3	Di:0003	Site:SHAUMBURG
06/14/1994	11:56:19	H1	memory left 263088			
06/14/1994	11:56:27	H1	Precinct list sent.			CH=2
06/14/1994	11:56:42	H1	Precinct list sent.			CH=3
06/14/1994	11:56:58	H1	SPR Connect	Ch=1	Di:0002	
06/14/1994	11:56:58	H1	Logged in.			
06/14/1994	11:56:58	H1	SPR Connect	Ch=1	Di:0002	Site:ROCHELLE
06/14/1994	11:56:58	H1	memory left 272128			
06/14/1994	11:57:17	H1	Precinct list sent.	Ch=1		
06/14/1994	11:57:24	H1 MD	Ch=4 District: 0004/ELK GROVE has disconnected.			
06/14/1994	11:57:49	H1 MD	Ch=3 District: 0003/SHAUMBURG has disconnected.			
06/14/1994	11:57:51	H1	SPR Connect	Ch=4	Di:0004	
06/14/1994	11:57:51	H1	Logged in.			
06/14/1994	11:57:51	H1	SPR Connect	Ch=4	Di:0004	Site:ELK GROVE
06/14/1994	11:57:52	H1	memory left 279504			
06/14/1994	11:57:55	H1	Precinct list sent.			CH=4
06/14/1994	11:57:59	H1 MD	Ch=1 District: 0002/ROCHELLE has disconnected.			
06/14/1994	11:58:52	H1	SPR Connect	Ch=1	Di:0002	
06/14/1994	11:58:52	H1	Logged in.			
06/14/1994	11:58:52	H1	SPR Connect	Ch=1	Di:0002	Site:ROCHELLE
06/14/1994	11:58:52	H1	memory left 272128			
06/14/1994	11:58:56	H1	SPR Connect	Ch=3	Di:0003	
06/14/1994	11:58:56	H1	Logged in.			
06/14/1994	11:58:56	H1	SPR Connect	Ch=3	Di:0003	Site:SHAUMBURG
06/14/1994	11:58:56	H1	memory left 259552			
06/14/1994	11:59:11	H1	Precinct list sent.			CH=1
6/14/1994	11:59:19	H1	Precinct list sent			CH=3
06/14/1994	11:59:20	H1 RV	1	CH=4	PK= 1	DI:0004 PR:0003 Pack Received.
06/14/1994	11:59:51	H1 RV	2	CH=1	PK= 1	DI:0002 PR:0002 Pack Received.
06/14/1994	12:00:00	H1 RV	3	CH=1	PK= 2	DI:0002 PR:0001 Pack Received.
06/14/1994	12:00:12	H1 MD	Ch=2	District: 0001/NORTHBROOK has disconnected.		
06/14/1994	12:00:13	H1 MD	Ch=4	District: 0004/ELK GROVE has disconnected.		
06/14/1994	12:00:14	H1 MD	Ch=1	District: 0002/ROCHELLE has disconnected.		
06/14/1994	12:00:16	H1 MD	Ch=3	District: 0003/SHAUMBURG has disconnected.		
06/14/1994	12:00:21	H1	Host End of session.			

Remote Log

06/14/1994	08:51:55	- - - - -
06/14/1994	08:51:55	Smart Pack Reader (Remote) v1.1 (c)1994 ES&S
06/14/1994	08:51:55	District/Site:0002 Remote Session:
06/14/1994	08:51:55	memory left 260224
06/14/1994	08:51:56	CF [election]
06/14/1994	08:51:56	CF electionfiles=mn-spec
06/14/1994	08:51:56	CF [device]
06/14/1994	08:51:56	CF baseaddress=3f8
06/14/1994	08:51:56	CF interrupt=4
06/14/1994	08:51:56	CF portsondevice=1
06/14/1994	08:51:56	CF port=9600,8,N,2,handshake,modem
06/14/1994	08:51:56	CF [site]
06/14/1994	08:51:56	CF district=0002
06/14/1994	08:51:56	CF districtname=ROCHELLE
06/14/1994	08:51:56	CF [display]
06/14/1994	08:51:56	CF lines=high,color
06/14/1994	08:51:56	CF [phone]
06/14/1994	08:51:56	CF dialingmode=TONE
06/14/1994	08:51:56	CF hostphone=1
06/14/1994	08:51:56	CF [access]
06/14/1994	08:51:56	CF password=12345678
06/14/1994	08:51:56	CF [pack]
06/14/1994	08:51:56	CF packtype=eagle
06/14/1994	08:51:56	CF packreadmode=many
06/14/1994	08:51:56	CF packimage=save
06/14/1994	08:51:56	CF [server]
06/14/1994	08:51:56	CF serverpath=c:\spr
06/14/1994	08:51:56	CF [host]
06/14/1994	08:51:56	CF hostpath=c:\spr
06/14/1994	08:51:56	CF [remote]
06/14/1994	08:51:56	CF remotepath=c:\spr
06/14/1994	08:51:56	CF
06/14/1994	08:51:56	SI Password 12345678
06/14/1994	08:51:56	SI District 0002
06/14/1994	08:51:56	SI Host Path C:\SPR\
06/14/1994	08:51:56	SI Server Path C:\SPR\
06/14/1994	08:51:56	SI Pack Type Eagle
06/14/1994	08:51:56	SI Modem Setup E0V1&D3&C1S0=2&W
06/14/1994	08:51:56	SI Status File C:\SPR\MN-SPEC.SPS
06/14/1994	08:51:56	SI Aero Pack File C:\SPR\MN-SPEC.SPP
06/14/1994	08:51:56	MD CH=1 Modem Init: E0V1&D3&C1S0=2&W
06/14/1994	08:52:00	MD Modem initialized.
06/14/1994	08:52:09	MD CH=1 Modem Dialing: L3M1DT,,1
06/14/1994	08:52:39	Attempting to log in to host. Ph#1
06/14/1994	08:52:45	Logged in to host: 1 BRC ROCKFORD
06/14/1994	08:53:04	Precinct list received.
06/14/1994	08:53:36	RD PR:0002 Pack read.
06/14/1994	08:53:37	PK PR:0002 Pack not in precinct list, appended to list.
06/14/1994	08:53:38	WR 1 PR:0002 Elk Grove Pack written to disk OK.
06/14/1994	08:53:38	AT 1 PR:0002 Elk Grove Attempting to send pack.
06/14/1994	08:53:43	SE 1 PR:0002 Elk Grove Pack sent.

continued

06/14/1994	08:53:45	RD PR:0001 Pack read.
06/14/1994	08:53:47	PK PR:0001 Pack not in precinct list, appended to list.
06/14/1994	08:53:47	WR 2 PR:0001 Elk Grove Pack written to disk OK.
06/14/1994	08:53:47	AT 2 PR:0001 Elk Grove Attempting to send pack.
06/14/1994	08:53:52	SE 2 PR:0001 Elk Grove Pack sent.
06/14/1994	08:54:02	Remote End of Session.

Pack Queue Displayer (AQ.EXE)

The program AQ.EXE simulates Election Reporting Manager's reading of packs received by the SPR Host. Its purpose is to test the flow of the packs from the remote to where Election Reporting Manager expects them to be.

The program can be used two ways:

- On one PC run the Acquisition Manager, and then run AQ.EXE. After receiving a pack at the SPR Host, exit the program and run AQ.EXE to display the packs received.
 - Run the Acquisition Manager and AQ.EXE on separate PCs connected by a LAN. On the LAN, the AQ.EXE program runs simultaneously with the SPR Host and will display the packs received.
1. To run the program, type **AQ [path][Electionname].SPP** at C:\SPR.
 2. Type **AQ [path][Electionname].SPP P** at C:\SPR, and the first forty counters will display too. The "p" option causes the program to display the first forty counters.

Pack Read Tester (PACKRDR.EXE)

The program PACKRDR.EXE will read the pack in the SPR and display the first forty counters. Its purpose is to verify that the reader interface in the SPR is working.

To run the program, insert a pack in the pack fixture and type **PACKRDR [packtype]**.

Example:

For an Eagle pack, type **PACKRDR EAGLE** and press ENTER.

For an OP3P pack, type **PACKRDR OP3P** and press ENTER.

Appendix D: Hardware Programming Manager and Acquisition Manager

Using Acquisition Manager with the Hardware Programming Manager

Before using Acquisition Manager, you must have coded the elections in Hardware Programming Manager for use with the Acquisition Manager.

Changing the System Control File

On the System Control File screen, shown below, you must enter **Y** in the **Using SPR?:** field.

```

PH069      Change E.H.S. Control File      3PMNSTC1

Border Color:RED          Available Colors are:
Entry Color:BROWN        Blue Green Cyan
Background:BLACK         Red Magenta Brown White

Display Color:CYAN

Error Color:WHITE
Background:RED

State:FL

Using AERO?:U           Backup Method:D
Using Voter Reg.?:Y     Using SPR?:Y ←
Using Ballot Gen?:M     Coding Center?:_
Polling place mode?:Y   Reset file flags?:
Using Network?:Y        Allow device names?:
                        Using Eagle modems?:
  
```

Current field: Y-BRC Coding Center
Previous value:

Creating the SPR Control File

On the Election Final Preparations menu, shown below, you must run the option to **Create - SPR Control File**. This program creates the [*election name*].SPL file that the SPR control program uses to group precincts to SPR's using district boundaries. The program will then read the precinct/poll records and write a record to the [*election name*].SPP file based on the district code that you specify here.

```

EMS (3.53 03-29-01)
ME006
Election Final Preparations Menu
03-29-01
02:52 pm
Selection:0_
3PMNSIC1
( 01 ) ..... Create - Final Election Database
( 03 ) ..... Create - Parameter File for Prom Packs
( 04 ) ..... List - Parameter File
( 05 ) ..... Burn - Precinct Prom Packs
( 06 ) ..... List - Prom Burning Status

( 14 ) ..... Create - SPR Control File ←
( 16 ) ..... Create - File for U/R
Enter ..... Exit from the Menu

```

1. Select Create SPR Control File from the menu. The screen will look similar to the one shown below.

```

PE109
Create the SPR Control File
3PMNSIC1

01 = Create the file
Enter = Exit back to Menu

Enter selection:1

Enter the District code used for SPR assignment:SPR
(Or leave blank for no assignment)

Should unassigned precincts be included in 00017: _ (Y or N)

```

2. Enter the established district **code** to use for SPR assignment. The district **number** must be a zero-filled numeric value of four digits. In the polling place mode, the district of the first precinct on the poll is used.
3. After you specify the district code to use, another field will display asking you whether unassigned precincts should be included in SPR number 0001. If you enter **Y** in this field, any precinct not assigned to any district being used for the SPR assignment will be put in SPR 0001. If you enter **N** in this field, those precincts will not be assigned to an SPR district.

When the file has been created, a message will display at the bottom of the screen telling you that it has been created. The screen will look like the one shown below.

PE109	Create the SPR Control File	3PMNSTC1
<p>01 = Create the file Enter = Exit back to Menu</p> <p>Enter selection:1</p> <p>Enter the District code used for SPR assignment:SPR (Or leave blank for no assignment)</p> <p>Should unassigned precincts be included in 0001?:Y (</p>		
<p>SPR Control file has been created!</p> <p>Press enter to return to menu</p>		

Running the SPR Precinct Results Update

1. On the desktop, click the **Election Reporting Manager** icon.
2. On the Election Reporting Manager menu, select the Election menu.

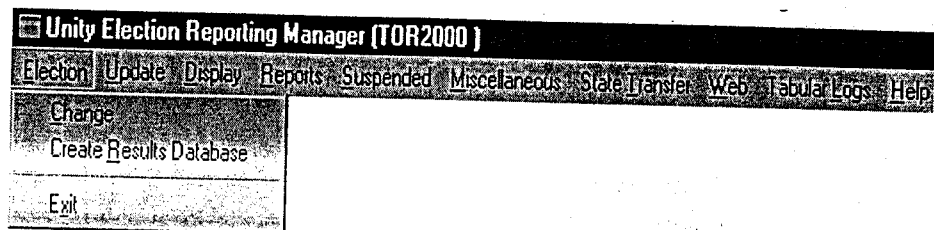

3. Select **Create Results Database**. The screen will look similar to the one shown below.

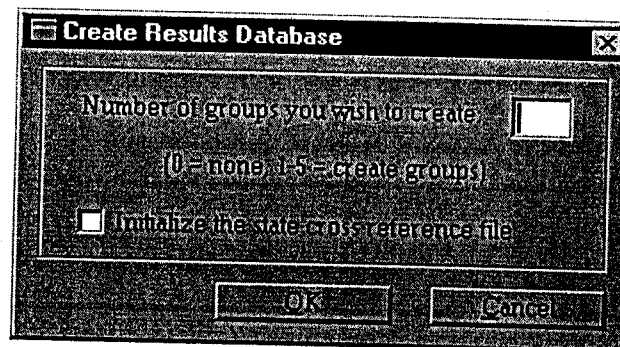

4. Enter the number of groups you want to create (1-5) in addition to the Election Day Totals that are created automatically.
5. Click **OK** to create the groups.

Refer to your **Unity Election Reporting Manager** user manual for more information on fields.

6. Select **Update** on the Election Reporting Manager menu.

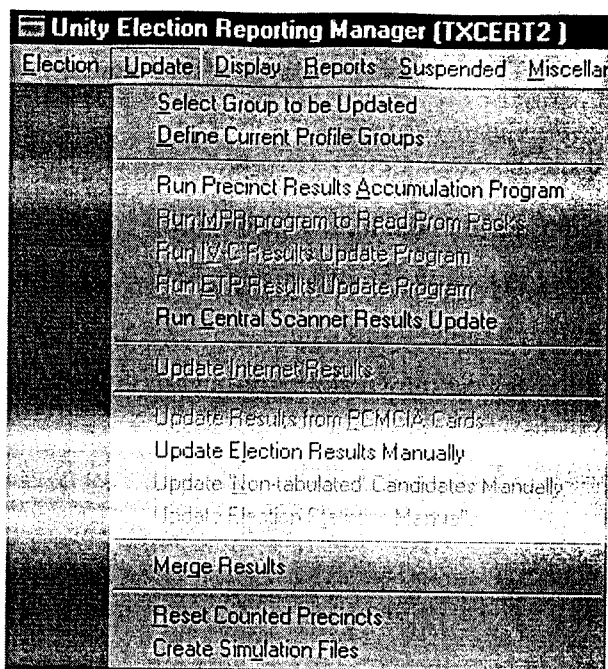

6. Select Run Precinct Results Accumulation Results Program. The screen will look similar to the one shown below.

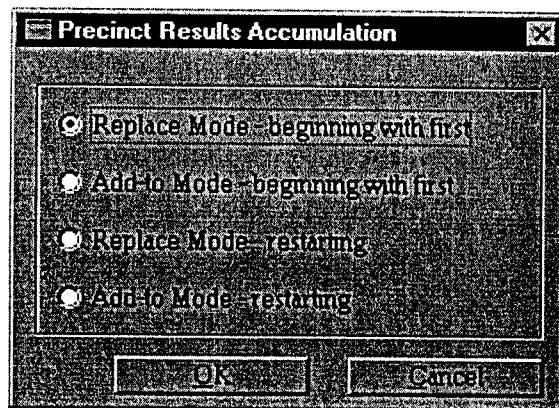

This program reads the pack images file created by the SPR control program and updates Election Reporting Manager with them.

7. Select one of the following:

- **Replace Mode - beginning with first**
Replaces existing results starting at the beginning of the file.
- **Add-to Mode - beginning with first**
Adds to existing results starting at the beginning of the file.
- **Replace Mode - restarting**
Replaces existing results starting with the next precinct after the last one updated.
- **Add-to Mode - restarting**
Adds to existing results starting with the next precinct after the last one updated.

Glossary

ASCII Text Files: American Standard Code for Information Interchange. ASCII text is stored in exactly the same order as you see it on a printed page, with no additional characters added or deleted. ASCII files are often called "print" files.

Arrow Keys: On your computer keyboard, the keys you use to navigate around your screen. Each key is marked with an arrow and is named for the direction in which the arrow points: There is an UP ARROW, DOWN ARROW, LEFT ARROW, and RIGHT ARROW key. Also known as direction keys.

Attribute: Any style used to enhance readability of text. Typical attributes include bold and italic.

Ballot Style: Also known as Ballot Changes, Ballot Faces and Candidate changes. It is the quantity of actual combinations of offices and candidates in a given election.

BIOS: The Basic input/output System or part of the computer operating system that communicates with the screen, the keyboard, printers, and other peripheral devices.

Bit: A binary digit is the smallest storage unit for data in a computer. **Buffer:** A temporary data storage area used by computers and some printers.

Check Box: A small, square box that appears in a dialog box which can be selected or cleared. When the check box is selected, an X appears in the box. A check box represents an option that you can turn on or off.

Choose: To use a mouse or keyboard to pick an item that begins an action in the Data Acquisition Manager. You choose commands on menus to perform tasks, and you choose icons to start applications.

Click: To press and release a mouse button quickly.

Close: To remove a window or dialog box, or quit an application. You can close a window by using the *Close* command on the Control menu. When you close an application window, you quit the application.

Confirmation Message: A message that appears after you specify certain actions, prompting you to confirm that you want to continue with the action or to specify that you want to cancel it.

Command Button: In a dialog box, a button that carries out an action. A command button often has a label that describes the action it carries out.

Delimiter: Most commonly used to refer to a character or code that marks the beginning or end of an item such as a sentence, record, or field.

Dialog Box: The set of choices presented on the screen for each menu option selected.

Double Click: To rapidly press and release a mouse button twice without moving the mouse. Double clicking carries out an action, such as starting an application.

DOS: The Disk Operating System is software that directs the flow of data between disk drives and your computer. Without an operating system, your computer can do nothing.

Drag: To move or select several items on the screen by selecting the item(s) and then pressing and holding down the mouse button while moving the mouse.

DWP: Also known as District Maps. DWP is the combination of precincts and groups within a county.

Extension: The part of the file name to the right of the period. For instance, the extension in the file name "96prim.BDF" is BDF. Extensions are used by the Election Data Manager to differentiate between files of different types.

File: A collection of information that has been given a name and is stored on a disk. This information can be a document or an application. Filename is the name of a file.

Font: A specific typeface, point size, and weight (e.g. 10pt Helvetica Bold)
Frame. A rectangular box used to hold text or graphics. The BIM uses the combination of different frames to create a unique ballot for an election.

Precinct: Also known as Voting Districts, Voting Assemblies. The smallest logical or physical entity (or area) your county breaks down into. It is also the smallest element for which a ballot can be produced.

Highlighted: Indicates that an object or text is selected and will be affected by your next action. Highlighted text appears in reverse video on monochrome monitors or in color on some color monitors. Highlighted objects might change color or be surrounded by a selection cursor.

Icons: Graphical representations of various elements in the Election Data Manager.

List Box: Within an application window or dialog box, a type of box that lists available choices - for example, a list of all files in a directory. If all the choices do not fit in the list box, there is a scroll bar.

Kilobyte (K): 1024 bytes of information or storage space.

Landscape: A page printed so that as you read it the width is greater than its height.

Layout: The arrangement of text and frames on any given page.

Leaders: Characters placed in the blank space after a candidate's name. For example: John Doe.

Leading: The distance in points from the baseline of one line of type to the next.

Maximize Button: The small box containing an up arrow at the right of the title bar. Mouse users can click the Maximize button to enlarge a window to its maximum size. Keyboard users can use the Maximize command on the Control menu.

Mechanical: A finished "camera ready" piece of artwork.

Megabyte (M): 1024 kilobytes (1,048,576 bytes) of information or storage space.

Memory: A computer's temporary data storage area (see RAM below).

Menu: A list of available commands in an application window. Menu names appear in the menu bar near the top of the window. You open a menu by selecting the menu name.

Menu Bar: The horizontal bar containing the names of the application's menus. It appears below the title bar.

Minimize Button: The small box containing a down arrow at the right of the title bar. Mouse users can click the Minimize button to reduce a window to an icon. Keyboard users can use the Minimize command on the Control menu.

Modem: A communications device that enables a computer to transmit information over a telephone line.

Open: To display the contents of a file in a window or to enlarge an icon to a window.

Pathname: A full pathname includes the drive, root and any sub directory names. Each name is separated by a backslash (\). For example, C:\Opt refers to the AIS BIM directory on the C drive.

Parallel Interface: An interface in which several bits of information (usually 1 byte) are transmitted simultaneously.

Parallel Printer: A printer that accepts information by way of a parallel interface.

Point: Typographic unit of measurement equal to 1/72 of an inch.

Pointer: The arrow-shaped cursor on the screen that follows the movement of a mouse and indicates which area of the screen will be affected when you press the mouse button. The pointer may change shape during certain tasks.

Port: A connection device between a computer and another component such as a printer or modem. For example, a printer cable is plugged into the printer port on the computer so information can be sent to the printer.

Portrait: A page printed so that, as you read it, the width of the page is less than its height.

PostScript: A language used to describe how to print a page that consists of both text and pictures. This description is completely independent of the printing device. This means that the page can be printed on any printer or typesetter that uses PostScript, and the page will be printed at the full resolution that each printer or typesetter can produce.

RAM: Random Access Memory is the working space or temporary storage area for the program you are using and the information on your screen. All information in RAM is lost unless it is saved prior to turning the computer off.

ROM: Read Only Memory contains information the computer uses to run the system. ROM is permanent and is not erased when the power is turned off.

Ruling Line: Any horizontal or vertical line used to separate text or frames from the surrounding layout.

Serial Interface: An interface in which information is transmitted one bit at a time.

Serial Printer: A printer that accepts information from the computer by way of a serial interface.

Scroll: To move through text (up, down, left, or right) in order to see parts of the file or list that cannot fit on the screen.

Scroll Arrow: An arrow on either end of a scroll bar that you use to scroll through the contents of the window or list box.

Scroll Bar: A bar that appears at the bottom and/or right edge of a window whose contents are not entirely visible. Each scroll bar contains a scroll box and two scroll arrows.

Scroll Box: In a scroll bar, the small box that shows the position of information currently in the window or list box relative to the contents of the entire window.

Select: To mark an item so that a subsequent action can be carried out on that item. You usually select an item by clicking it with a mouse or pressing a key. After selecting an item, you choose the action that you want to affect the item.

Static: The offices that are running either statewide or countywide.

Text Box: In a dialog box, a box in which you type information needed to carry out a command. The text box may be blank or may contain text when the dialog box opens.

Title Bar: The horizontal bar (at the top of a window) that contains the title of the window or dialog box. On many windows, the title bar also contains the Control menu box and Maximize and Minimize buttons.

Window: A rectangular area on your screen in which you view an application or document. You can open, close, and move a window, and change the size of most windows. You can open several windows at a time, and you can often reduce a window to an icon or enlarge it to fill the entire monitor screen. Sometimes windows are displayed within other windows.

WYSIWYG: Industry standard acronym for "What You See Is What You Get." Refers to the ability to display on the computer screen a close representation of what is printed.



The following products and services are available from ES&S:

Unity Election System™

Election Data Manager™
Ballot Image Manager™
Ballot on Demand™

Hardware Programming Manager™
Data Acquisition Manager™
Election Reporting Manager™

Profile Voter Registration Systems™

Power Profile™
Mega Profile™
State Profile™

Ballot Counting Systems

Systems for use at the Precinct or Polling Place – Electronic Ballot:

Votronic® DRE Touch Screen Voting System
V-2000 Full Face DRE Touch Panel Voting System
EZ-Access Voting™ ADA Compliant Voting Kiosk

Systems for use at the Precinct or Polling Place – Paper Ballot:

Model 100 OMR System
Model 2100 Punch Card System

Systems for use at Central or Regional Locations – Paper Ballot:

Model 150 OMR System
Model 550 OMR System
Model IV-C OMR System

Election Services and Support

On-site Training and Election Day Support
Election Programming Services
Comprehensive Training Programs and Tools
Maintenance Programs

Toll Free Phone and On-line Support
Ballot Printing Services
Systems and Procedures Documentation
Complete Inventory of Election Supplies

If you would like more information on any of our products or services please contact us:

Election Systems & Software, Inc.
11208 John Galt Blvd.
Omaha, NE 68137
Phone: 402-593-0101
Toll Free Inside the U.S.: 1-800-247-8683
Fax: 402-593-8107
Visit our website at www.essvote.com

Advancing the Way the World Administers Elections

1945

1. The first part of the report deals with the general situation of the country and the progress of the war.

2. The second part of the report deals with the economic situation and the progress of the war.

3. The third part of the report deals with the social situation and the progress of the war.

4. The fourth part of the report deals with the political situation and the progress of the war.

5. The fifth part of the report deals with the military situation and the progress of the war.

6. The sixth part of the report deals with the diplomatic situation and the progress of the war.

7. The seventh part of the report deals with the cultural situation and the progress of the war.

8. The eighth part of the report deals with the scientific situation and the progress of the war.

